

# Kids' cute crossover tee

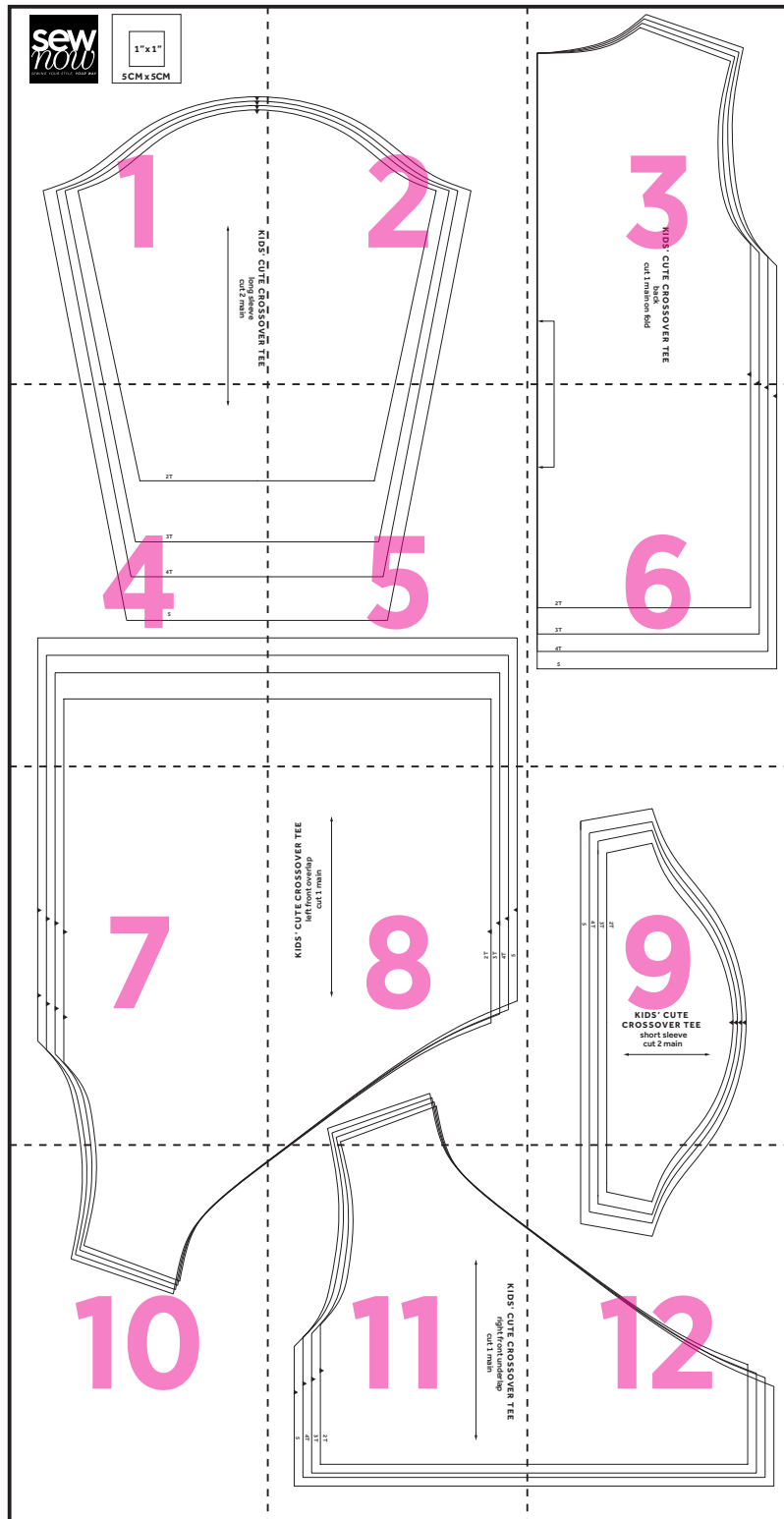

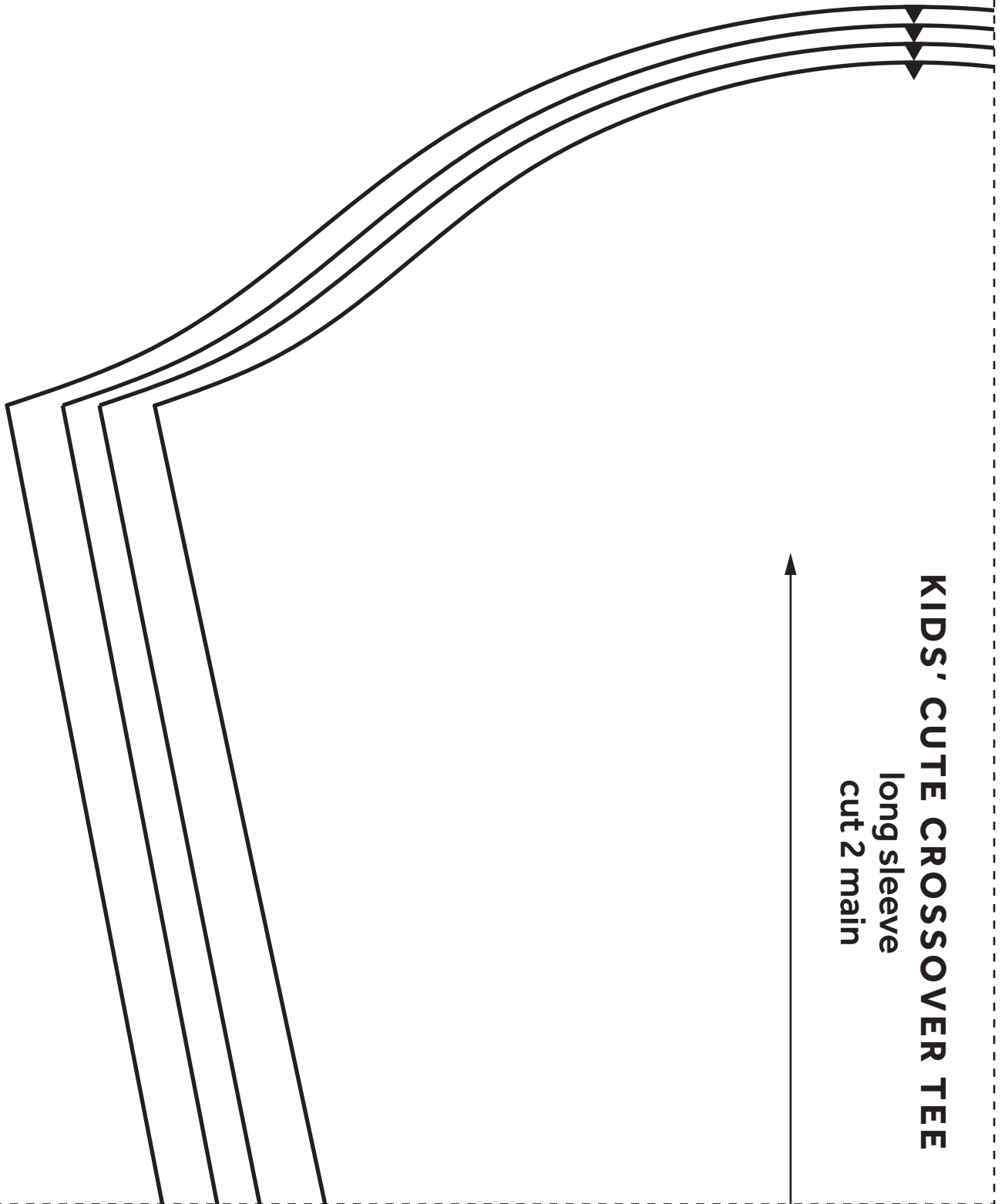
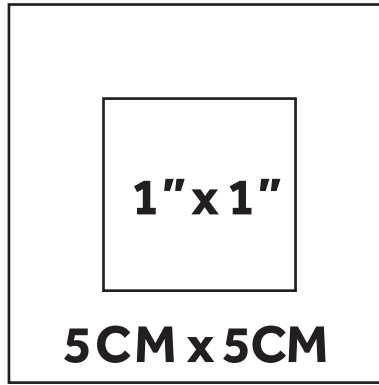

**KIDS' CUTE CROSSOVER TEE**  
long sleeve  
cut 2 main

2

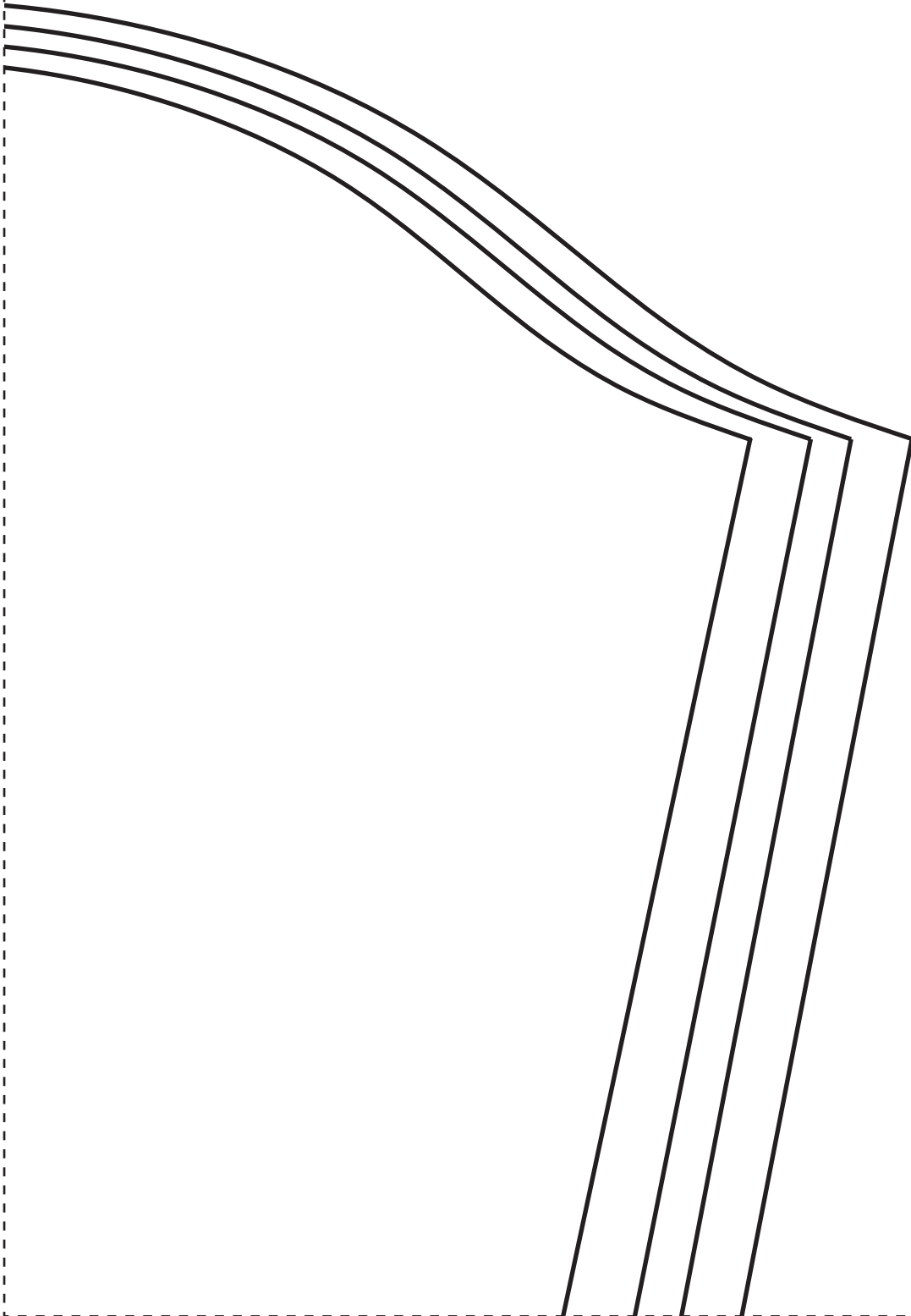



**3**

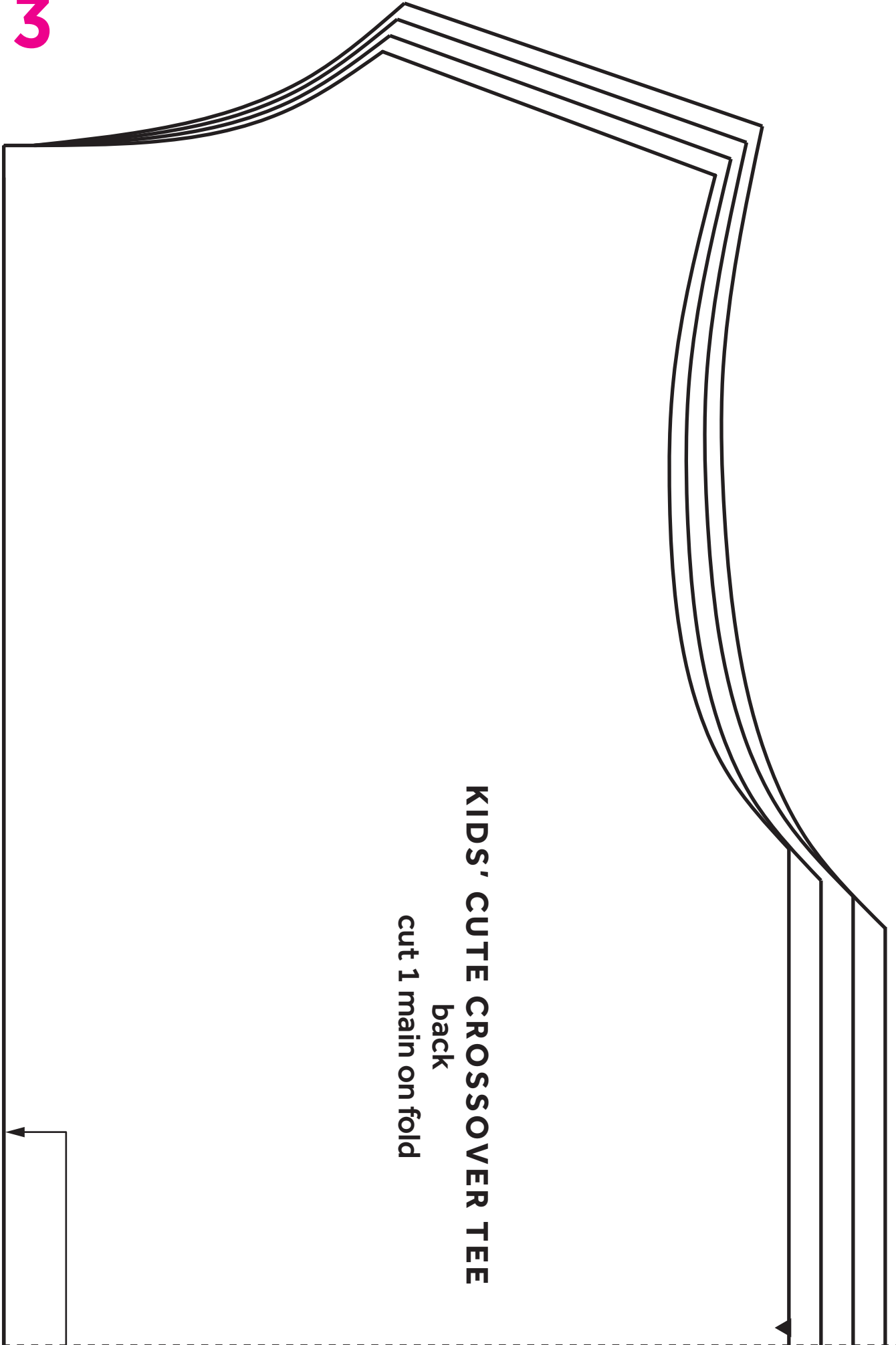

**KIDS' CUTE CROSSOVER TEE**  
back  
cut 1 main on fold

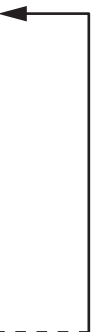

4



2T

3T

4T

5

5

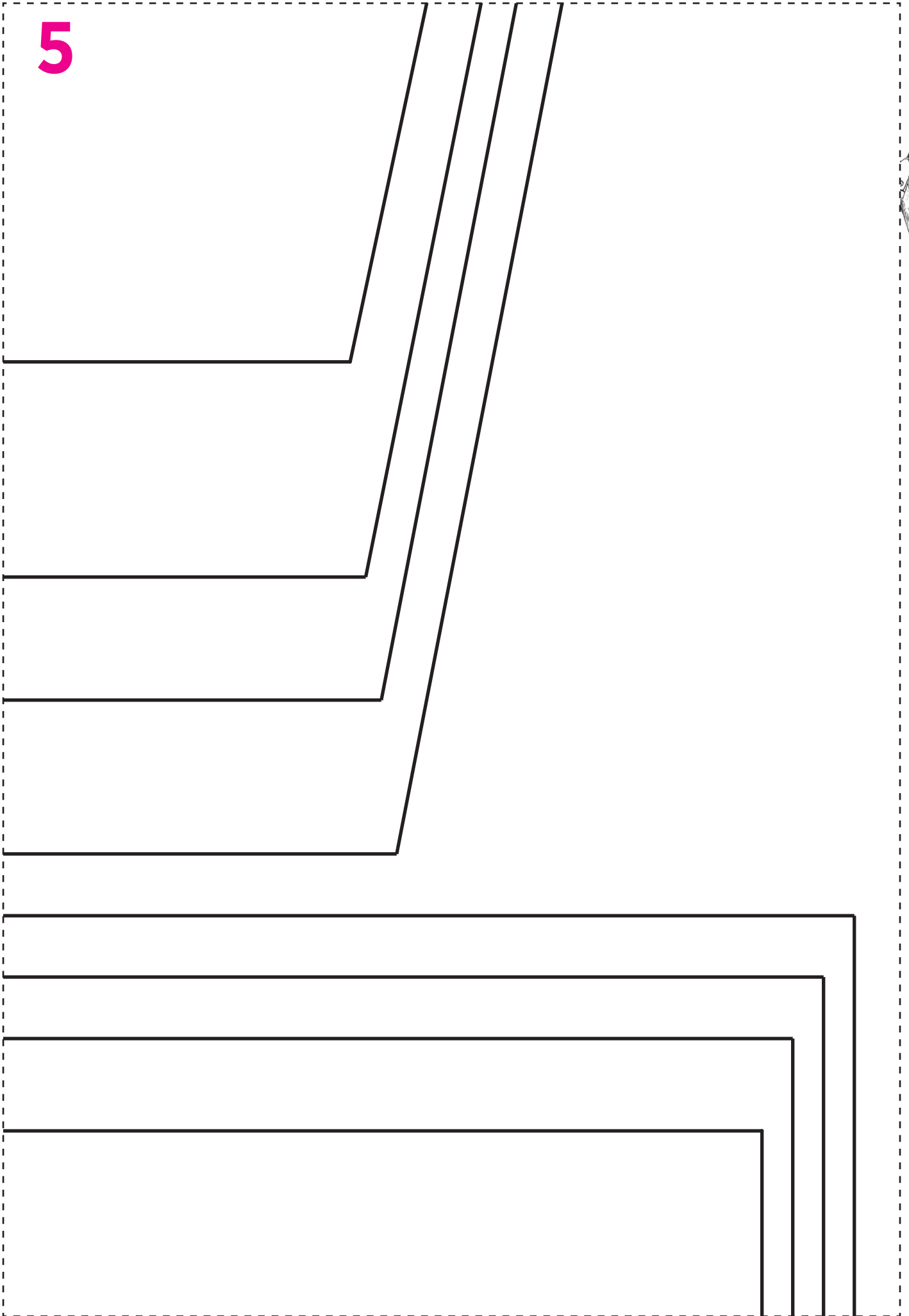

6

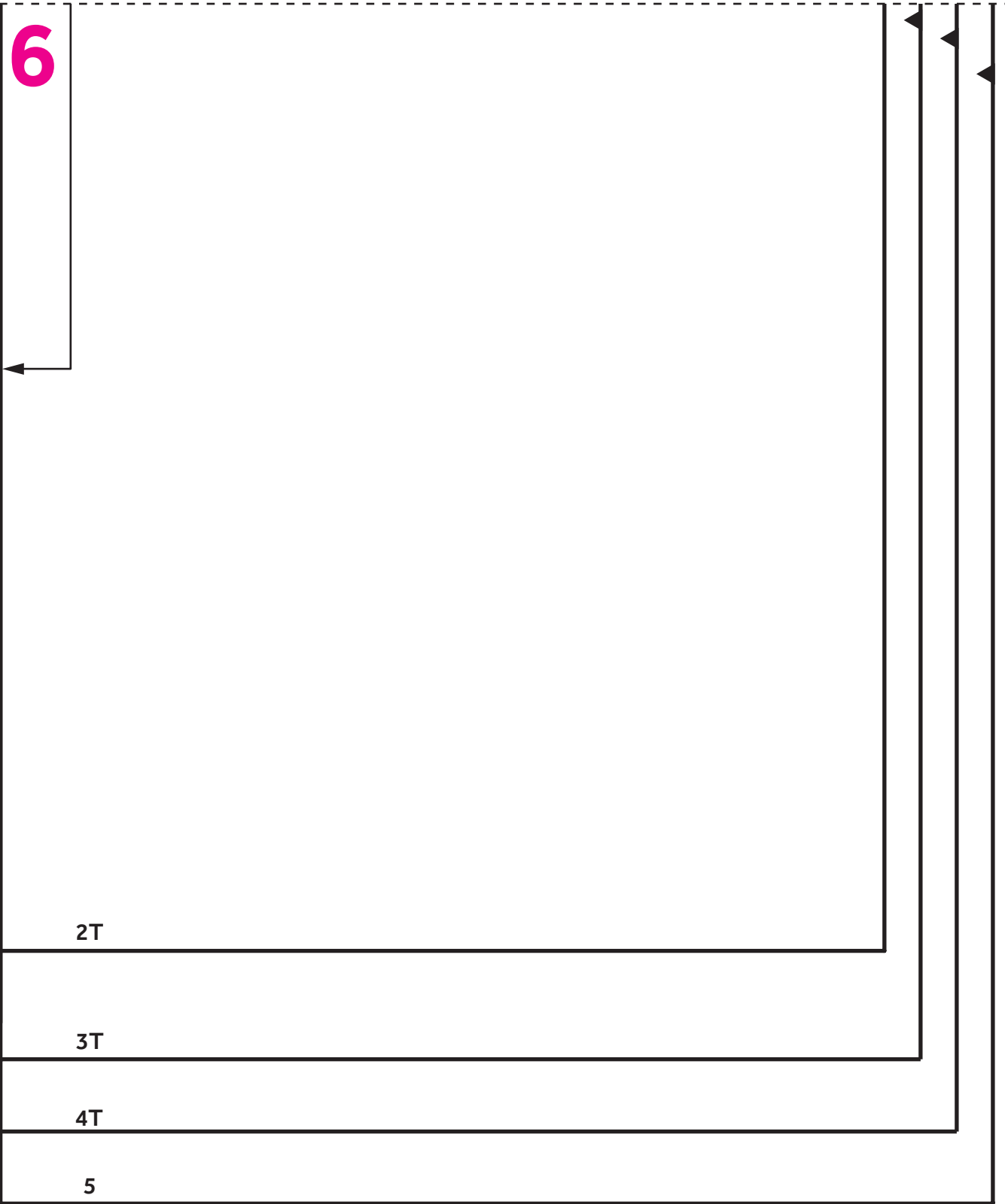

7

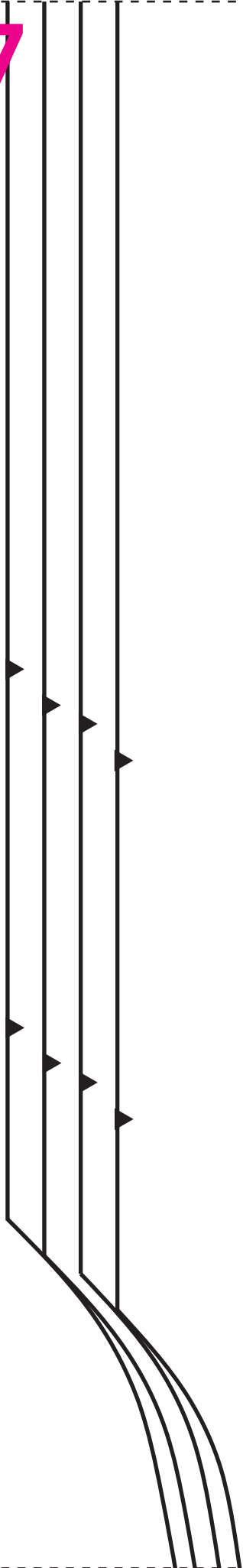



# KIDS' CUTE CROSSOVER TEE

left front overlap

cut 1 main

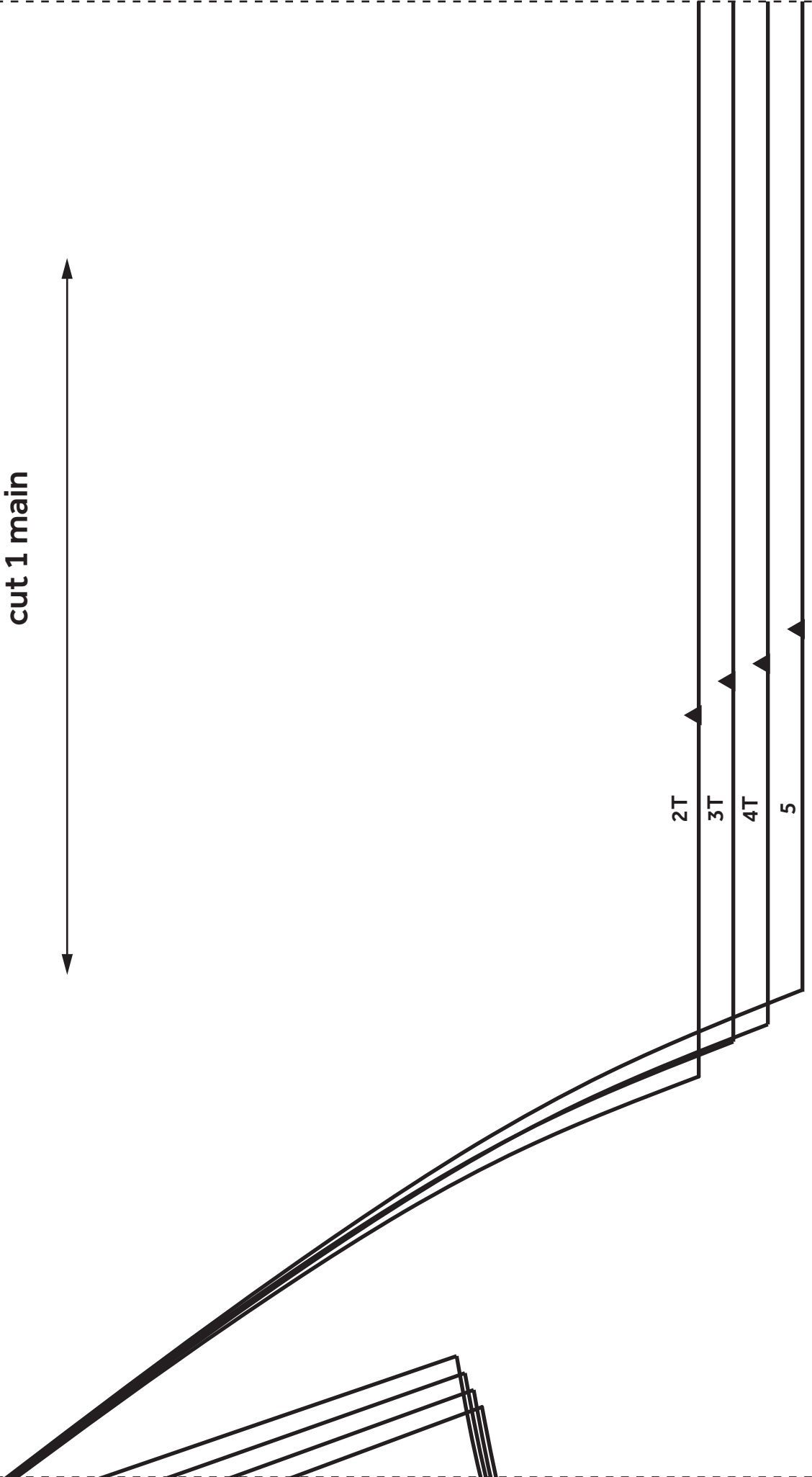

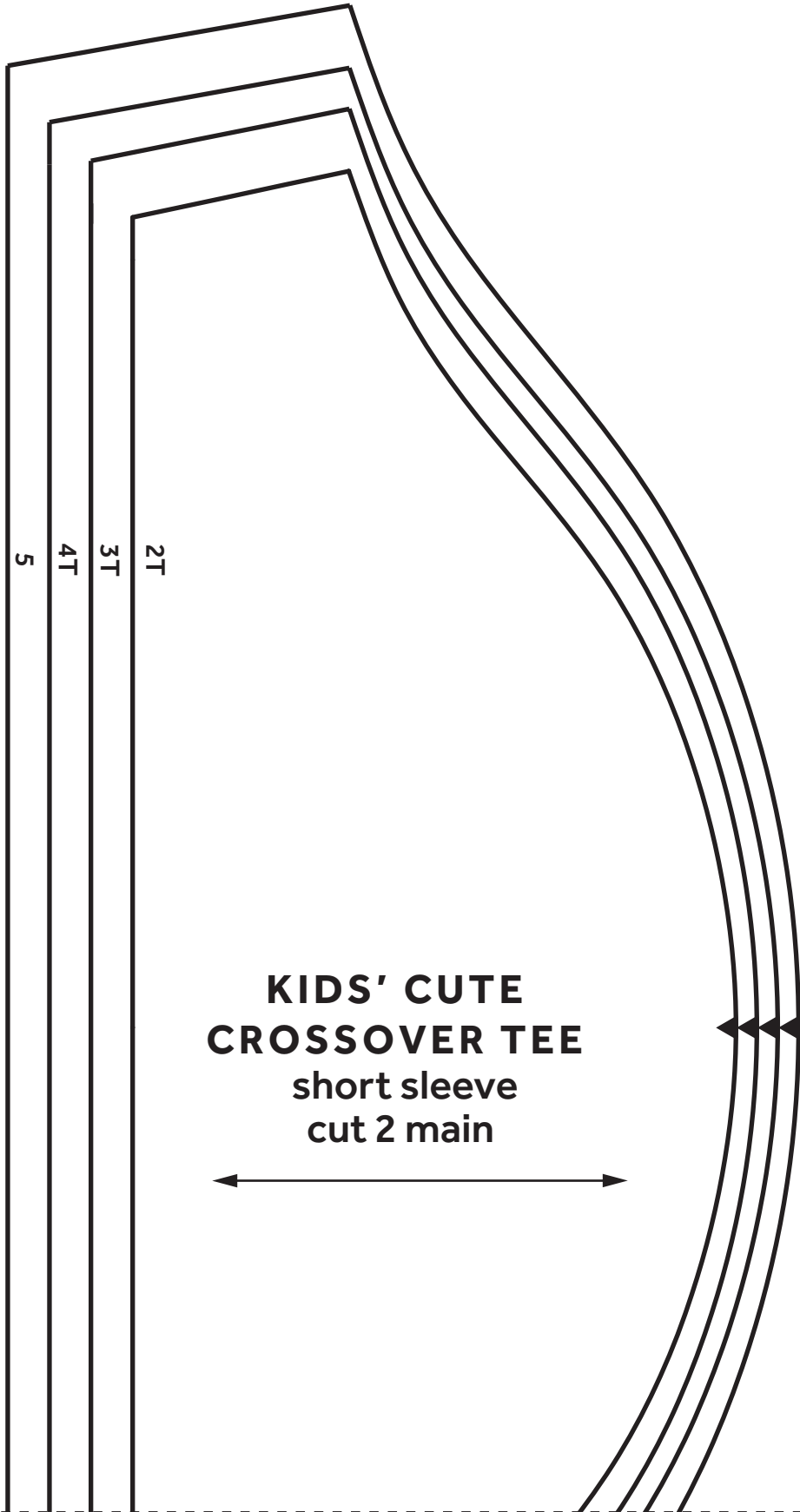

**KIDS' CUTE  
CROSSOVER TEE**  
short sleeve  
cut 2 main



10

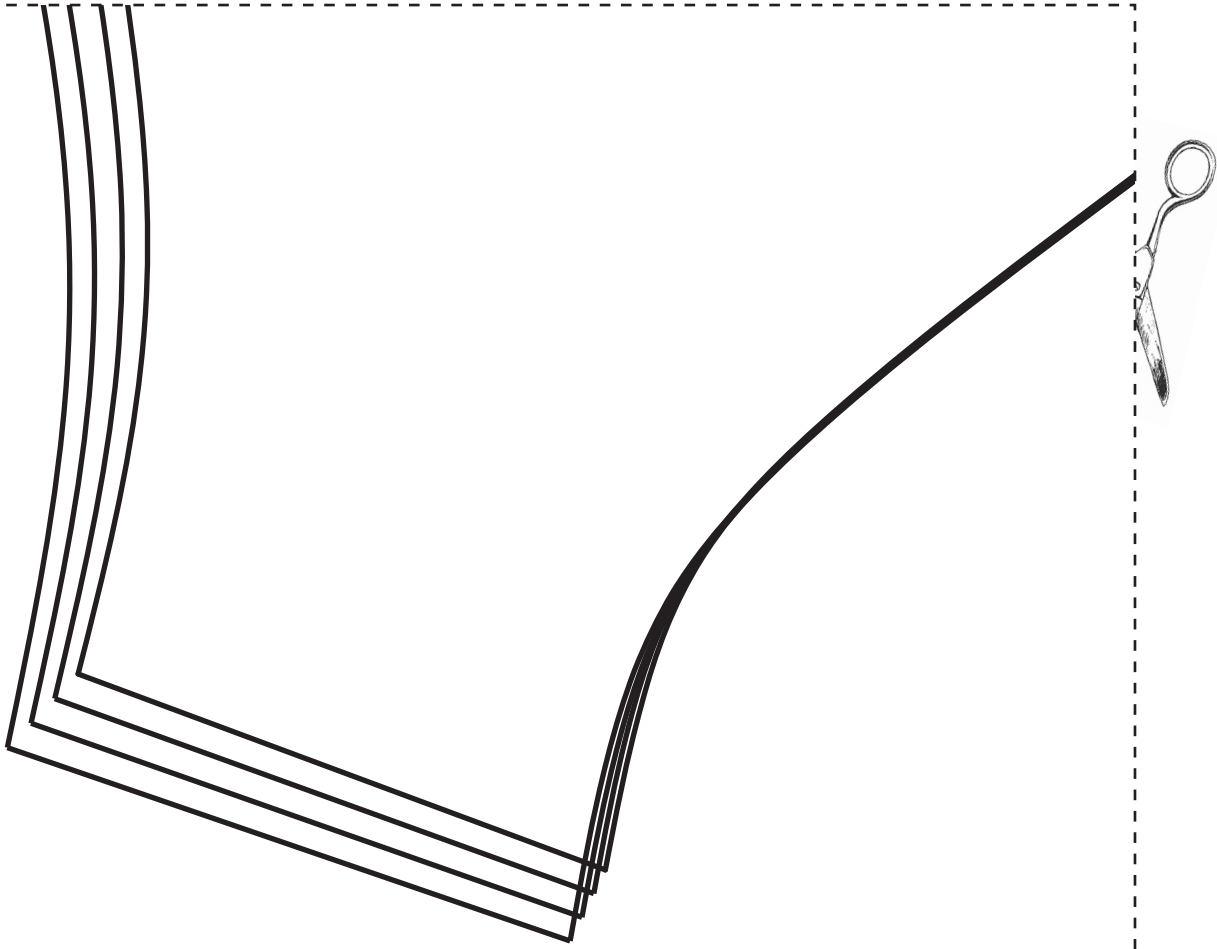

11



# KIDS' CUTE CROSSOVER TEE

right front underlap  
cut 1 main

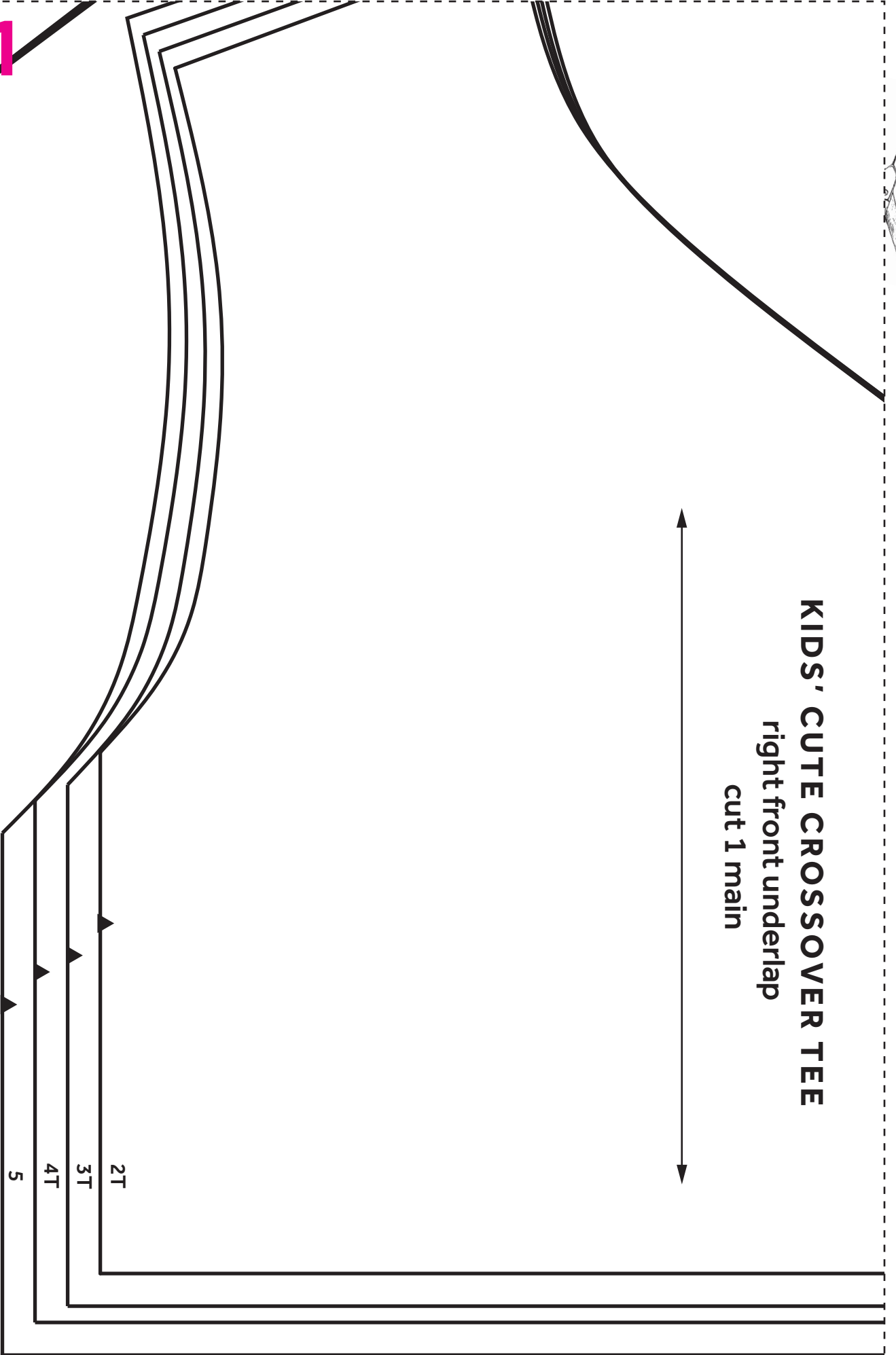

12

