

PENNY POCKET A-LINE SKIRT

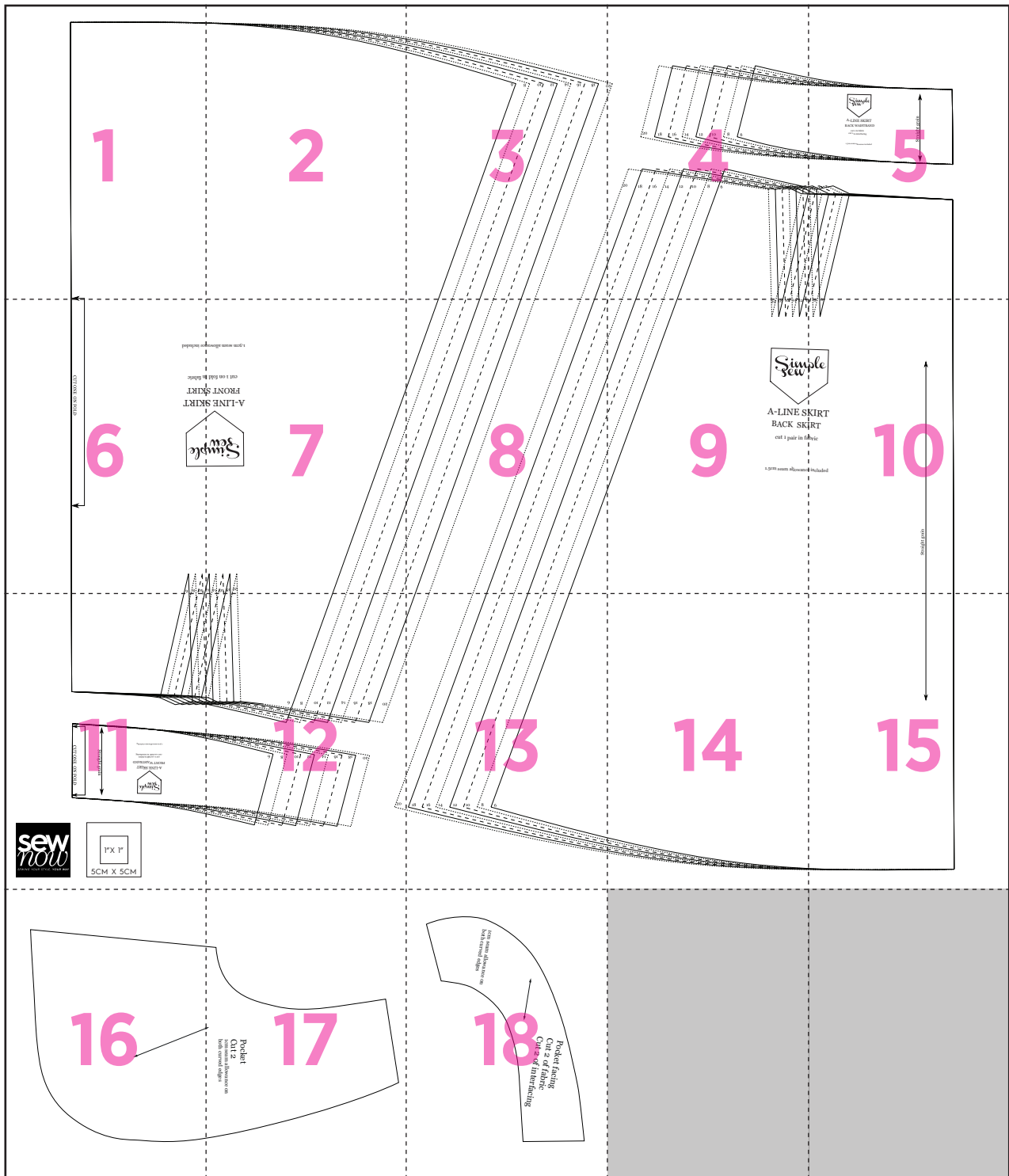

1



2

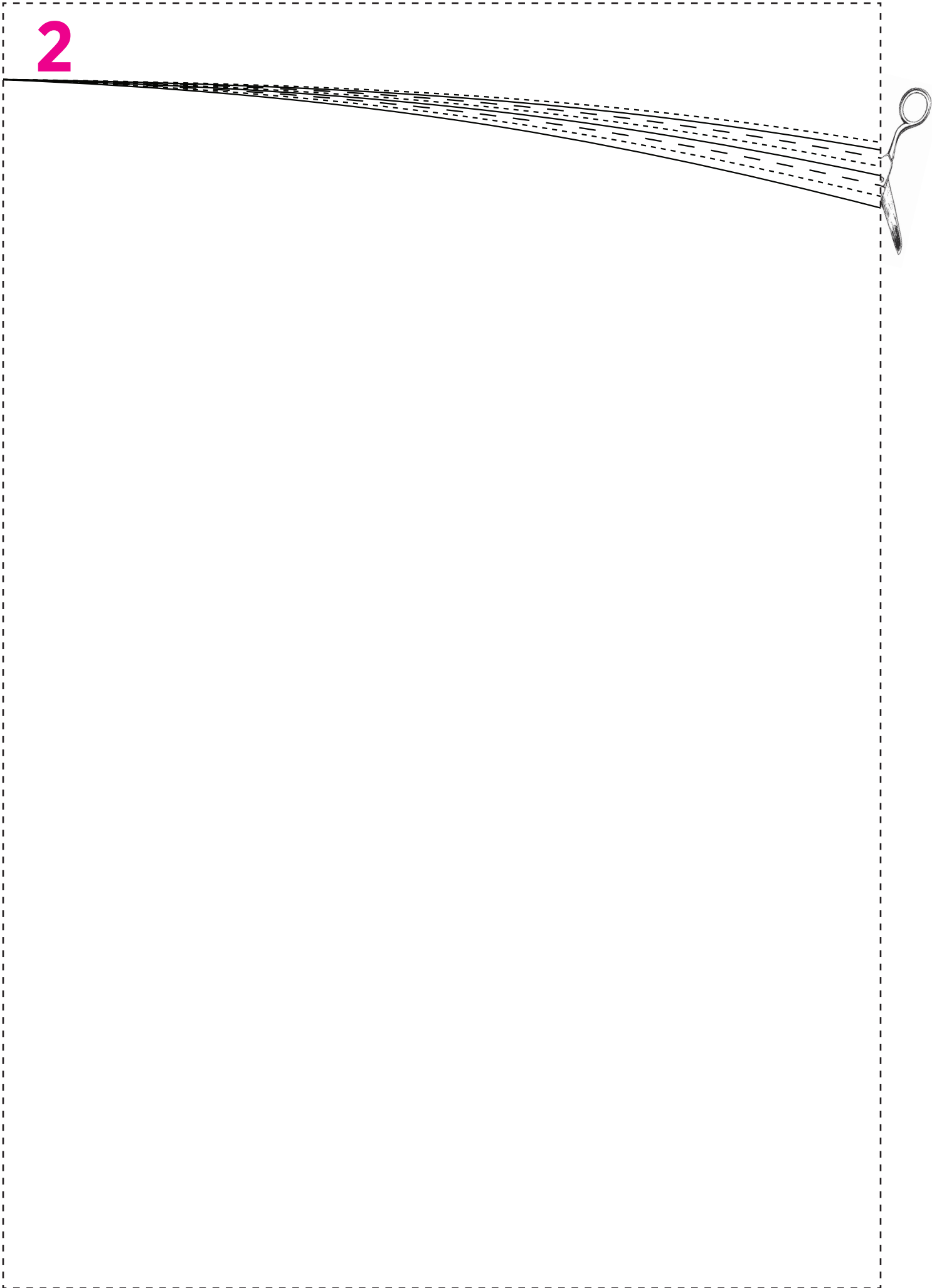

3

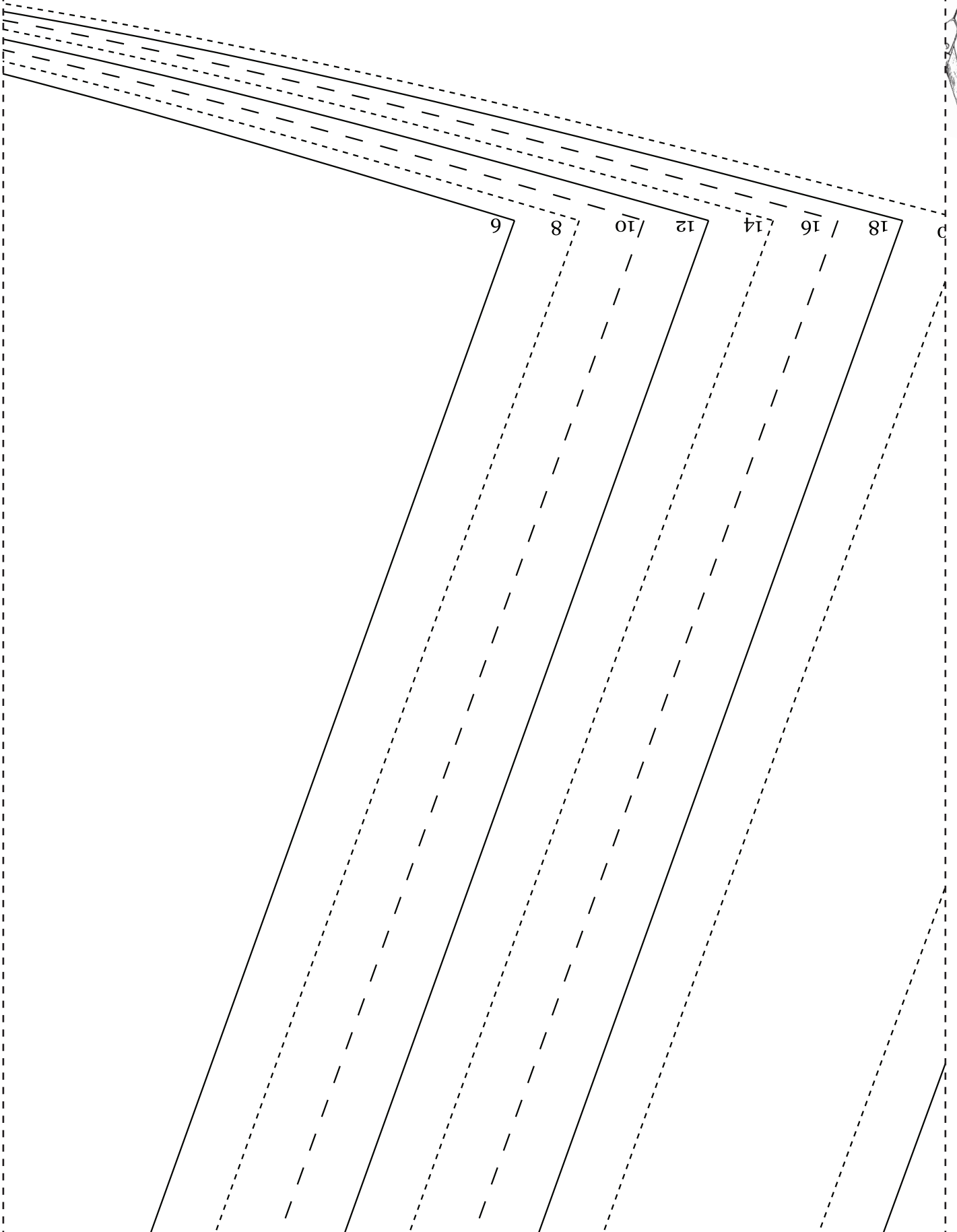

4



12

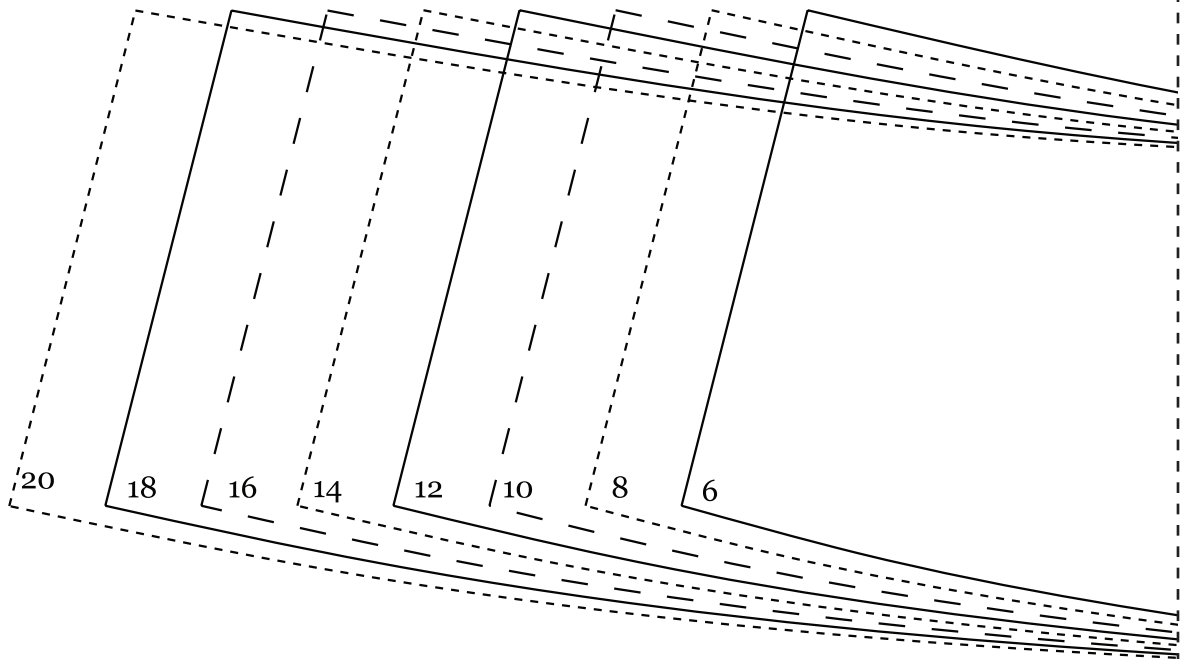

20 18 / 16 14 12 / 10 8 6

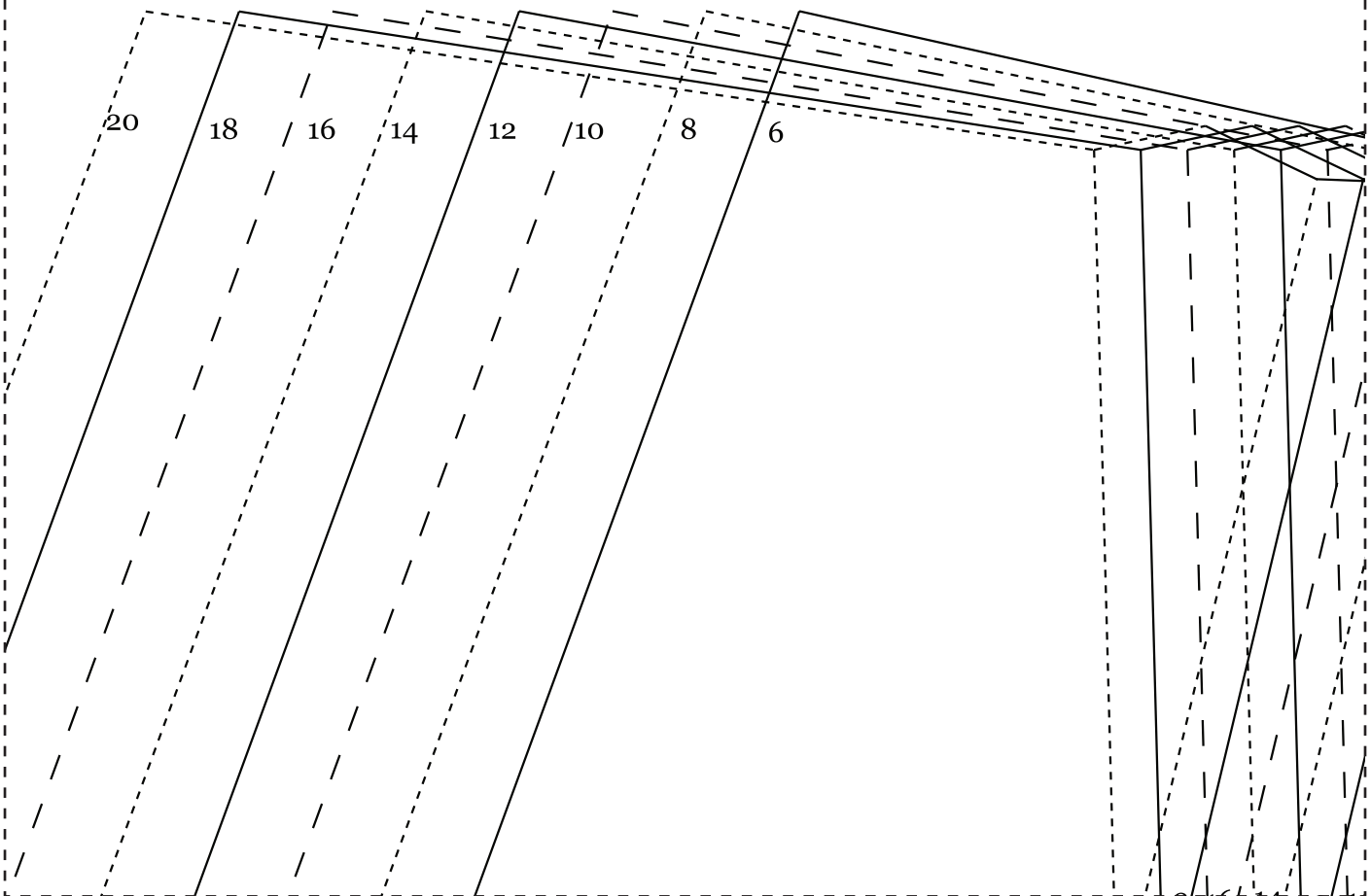

5

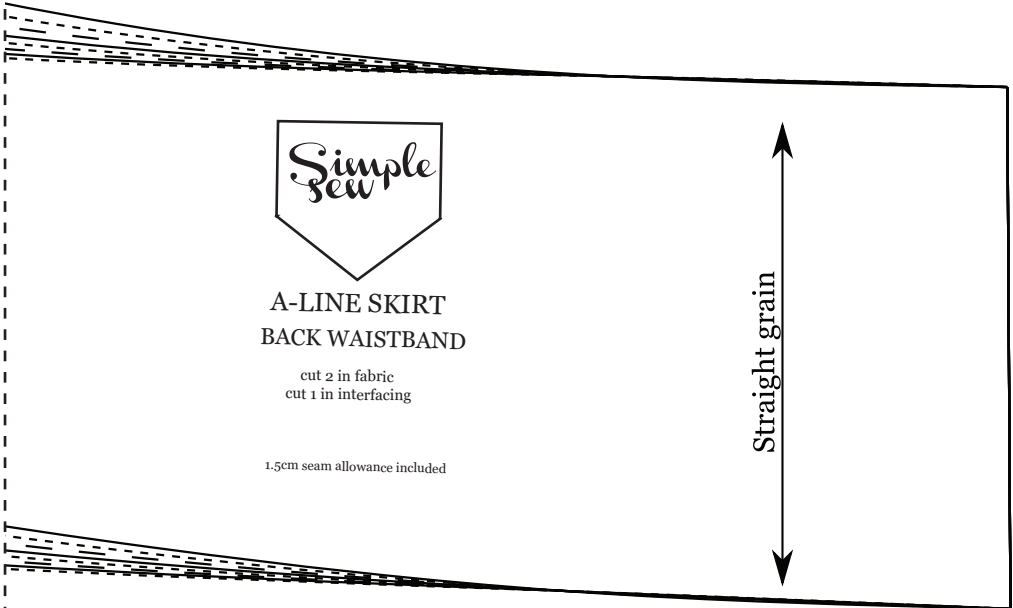

A-LINE SKIRT
BACK WAISTBAND

cut 2 in fabric
cut 1 in interfacing

1.5cm seam allowance included

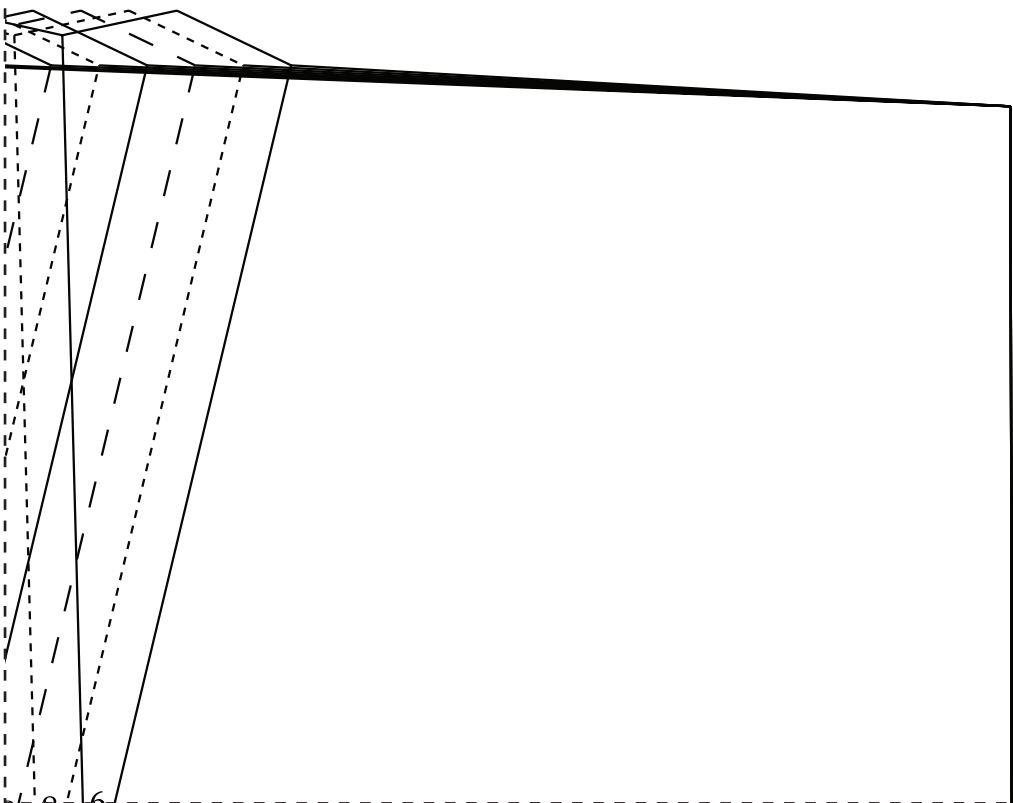

6

CUT ONE ON FOLD



KIRT
KIRT
in fabric

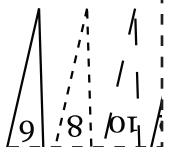

7

1.5cm seam allowance

cut 1 on fold

A-LINE S
FRONT S

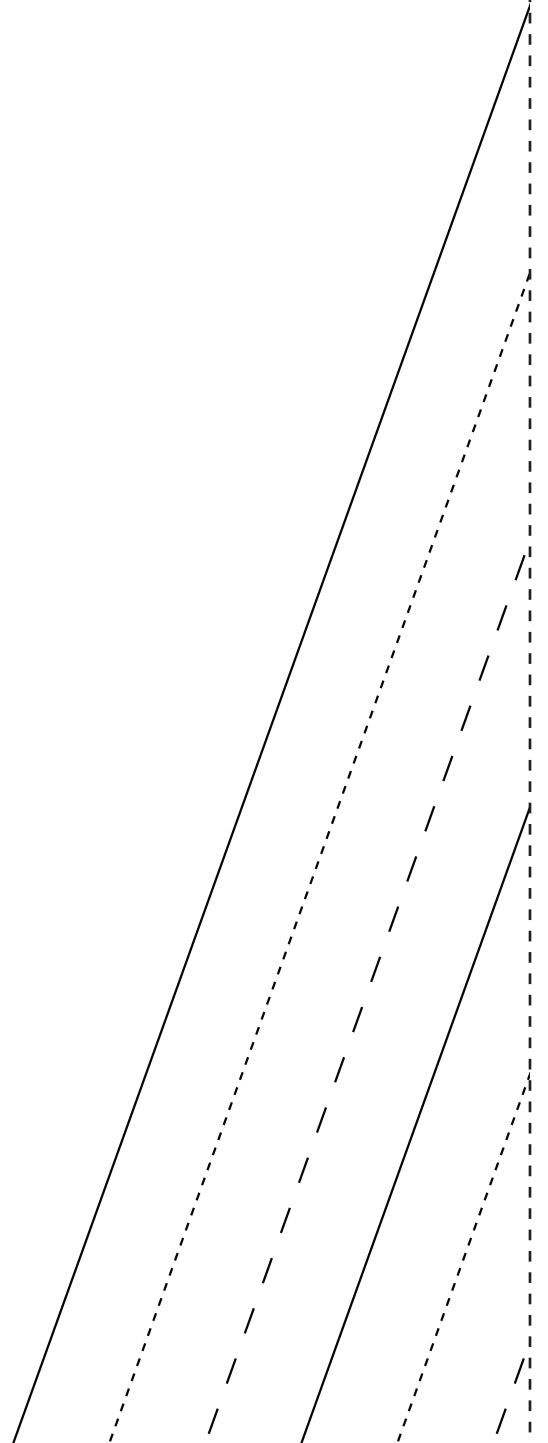
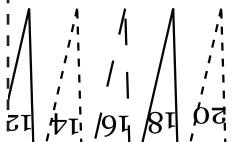

8

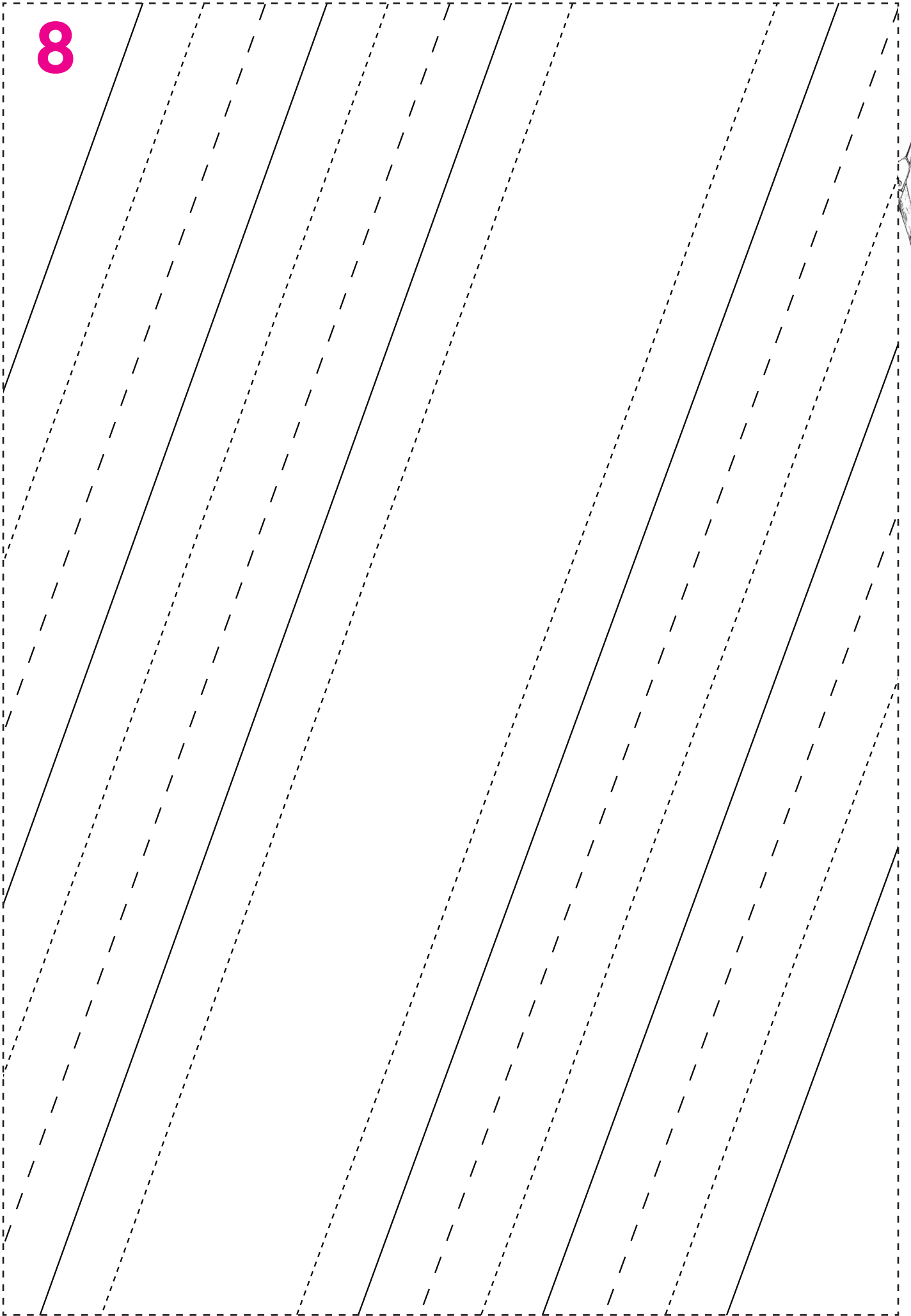

9

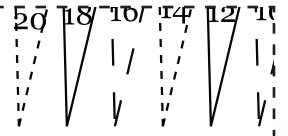

A-LINE SKIRT
BACK SKIRT

cut 1 pair in fabric

1.5cm seam allowance

10

ple

KIRT

IRT

bric

e included

Straight grain



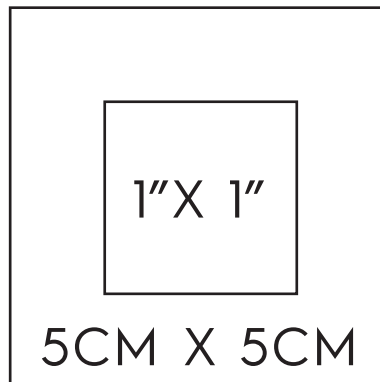
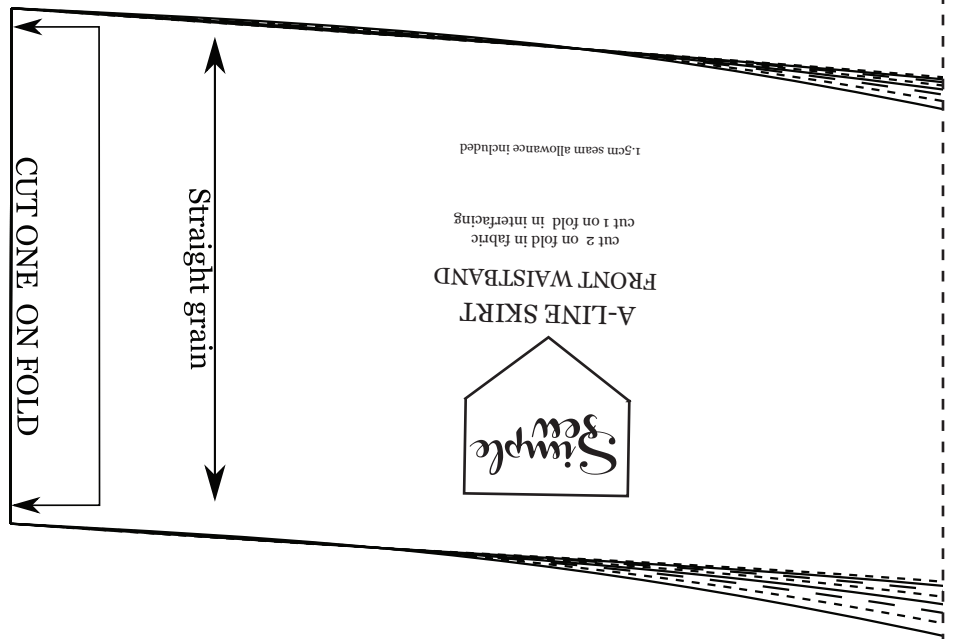
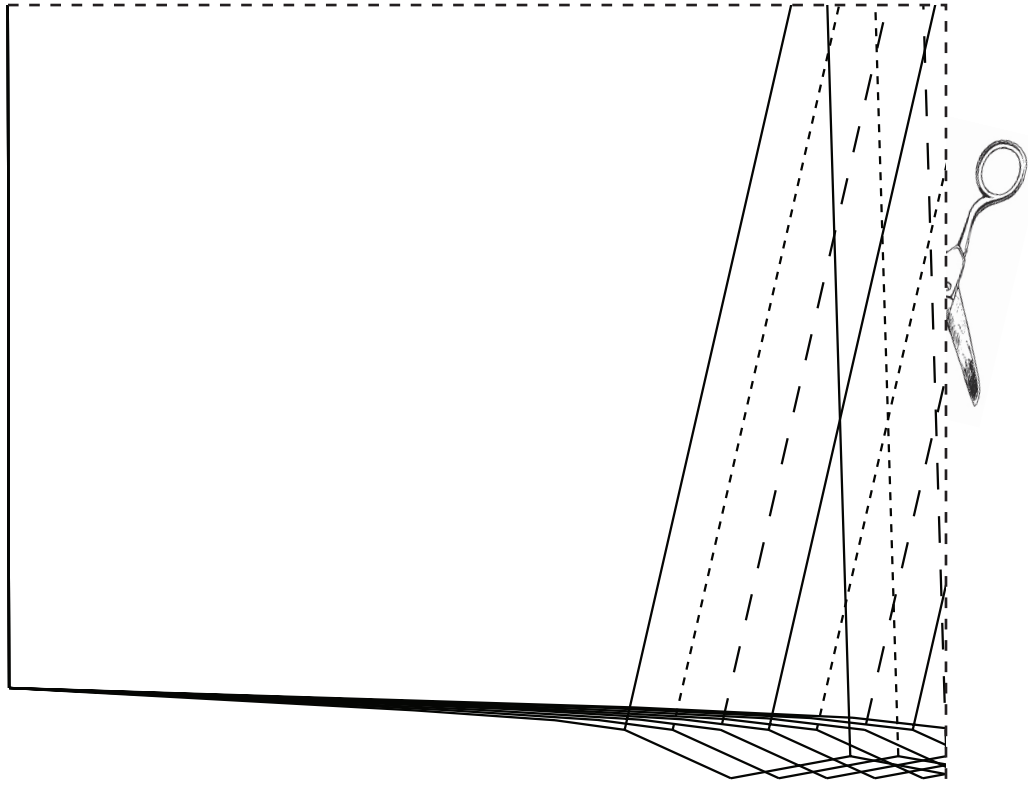

12

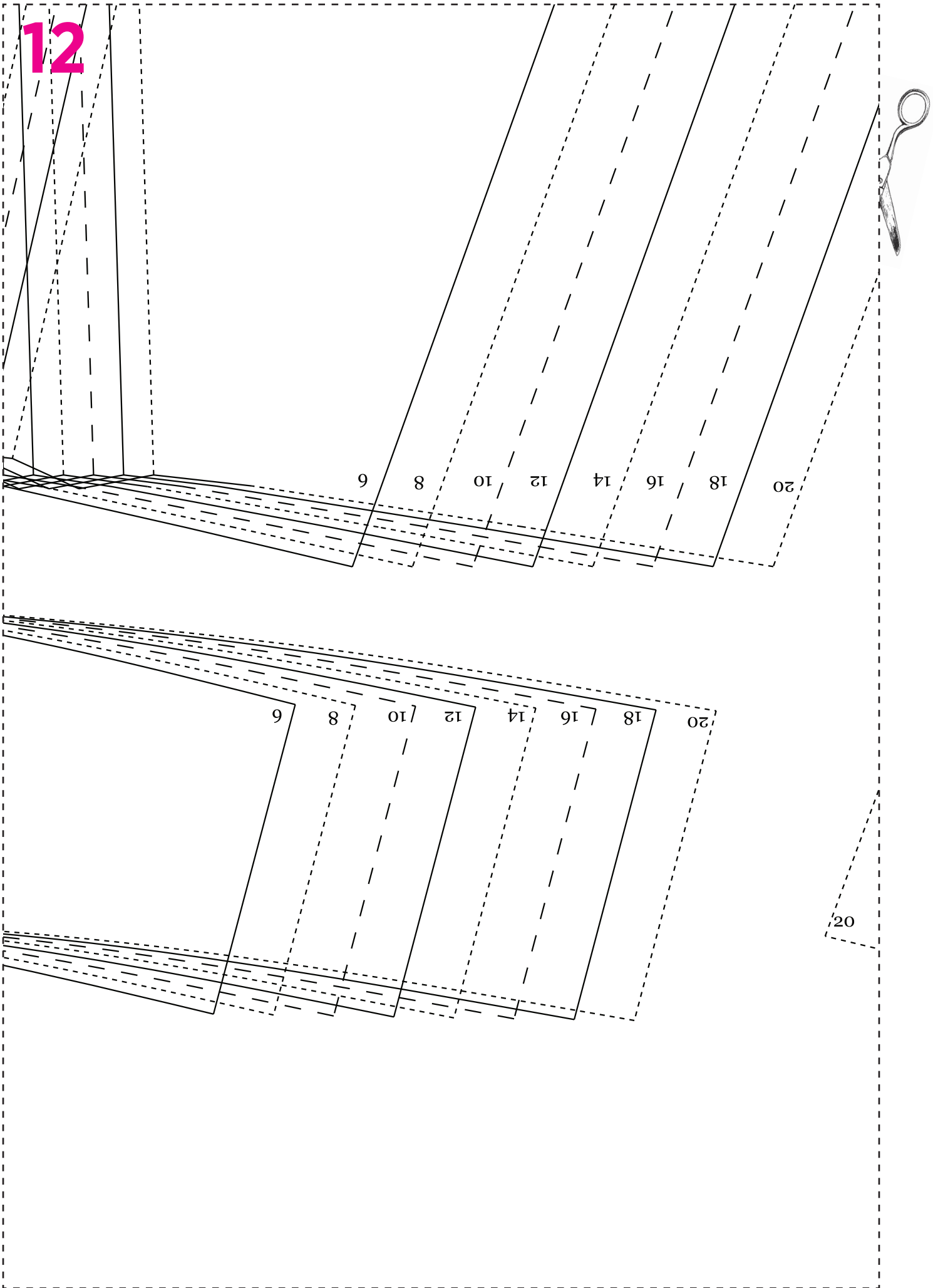

13

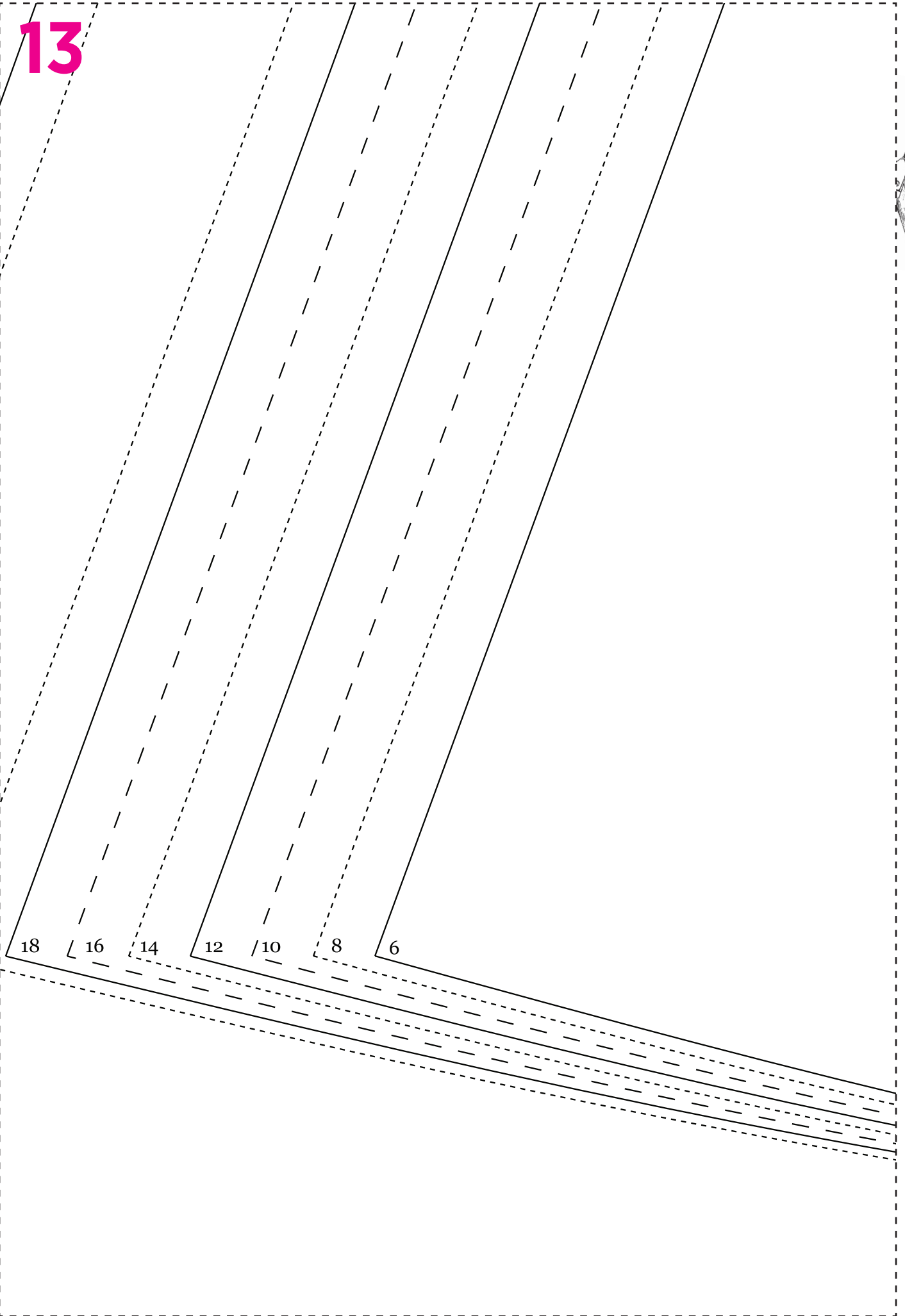

14

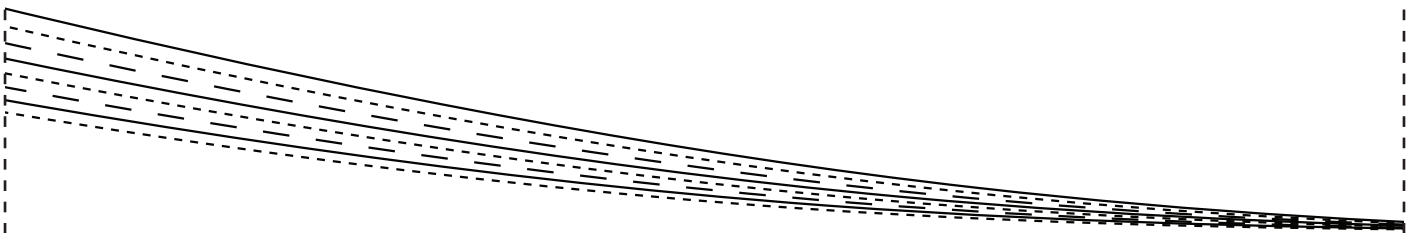

15



16

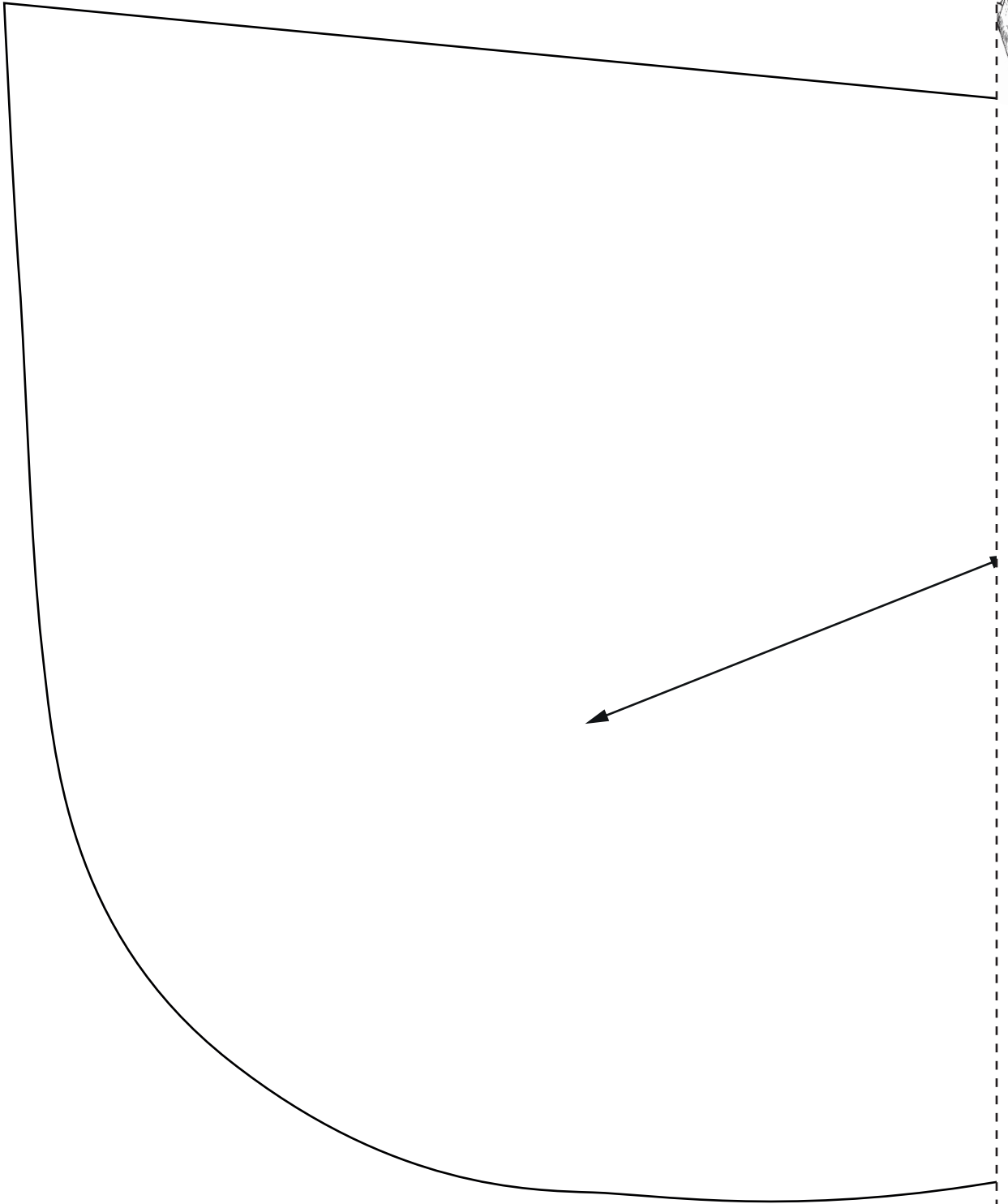

17

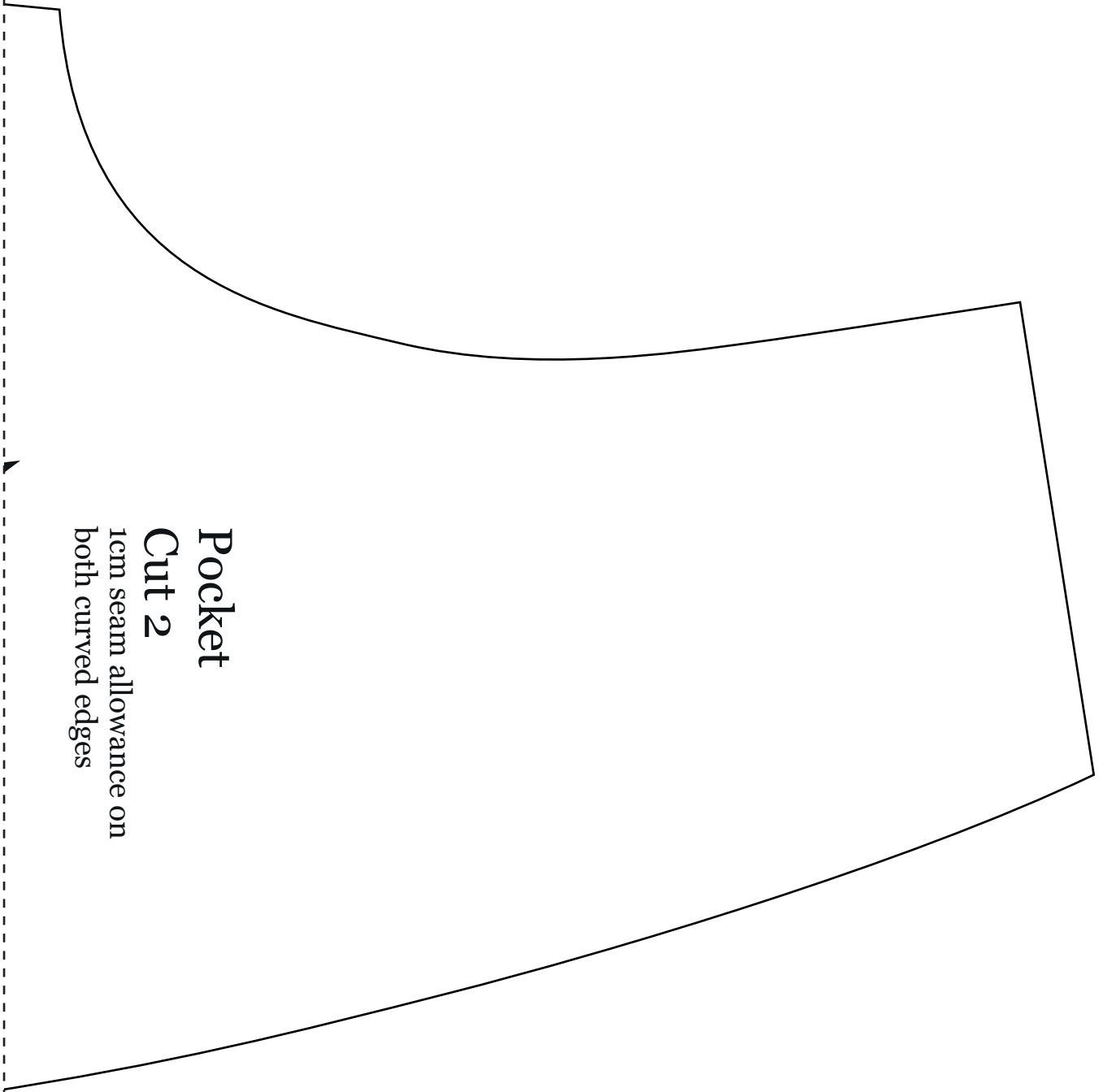

Pocket
Cut 2
1cm seam allowance on
both curved edges

