

CHIC WRAP DRESS (BODICE)

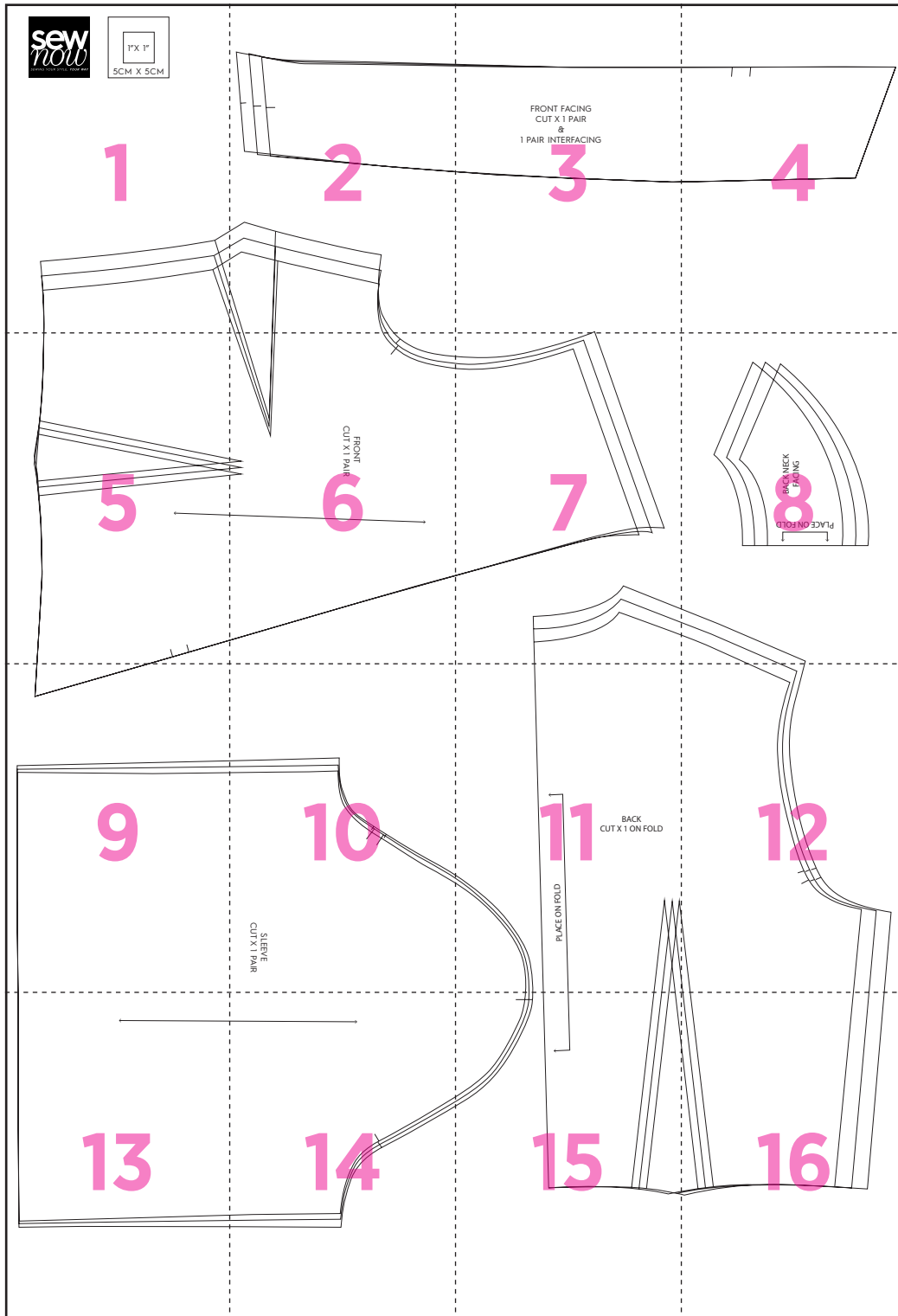

1

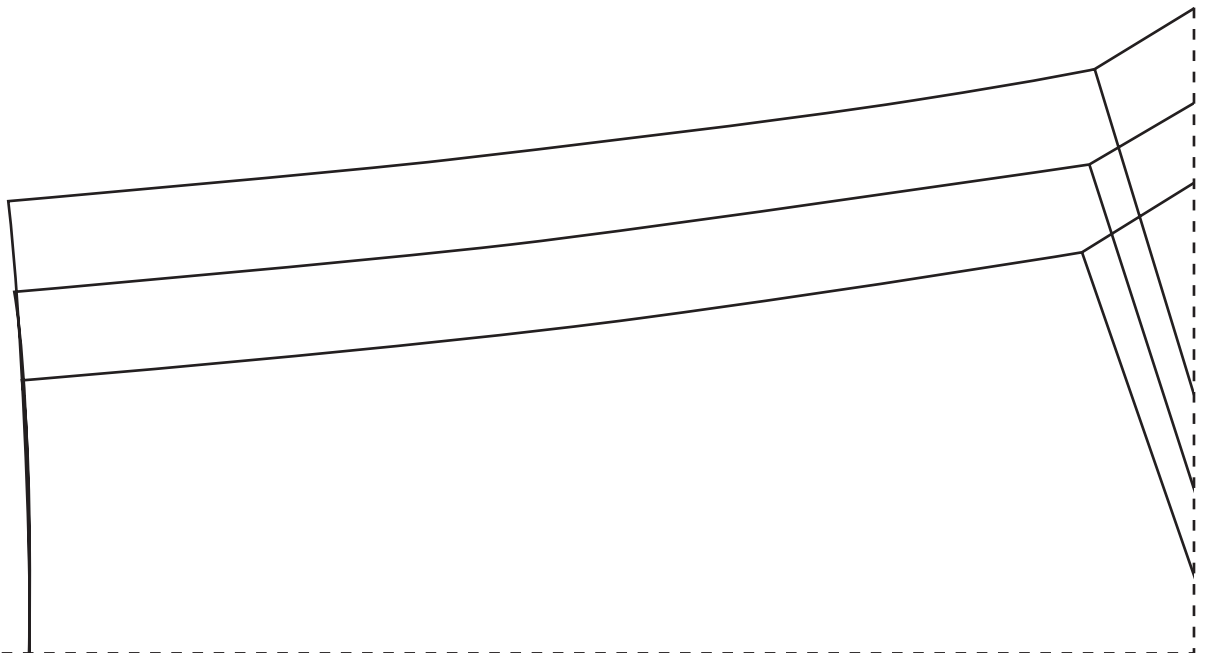
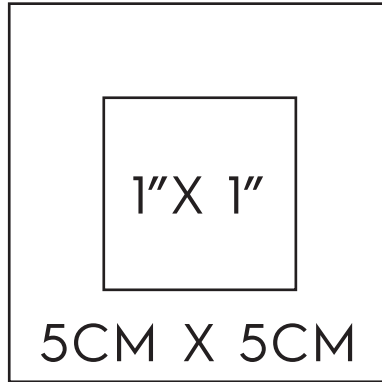

2

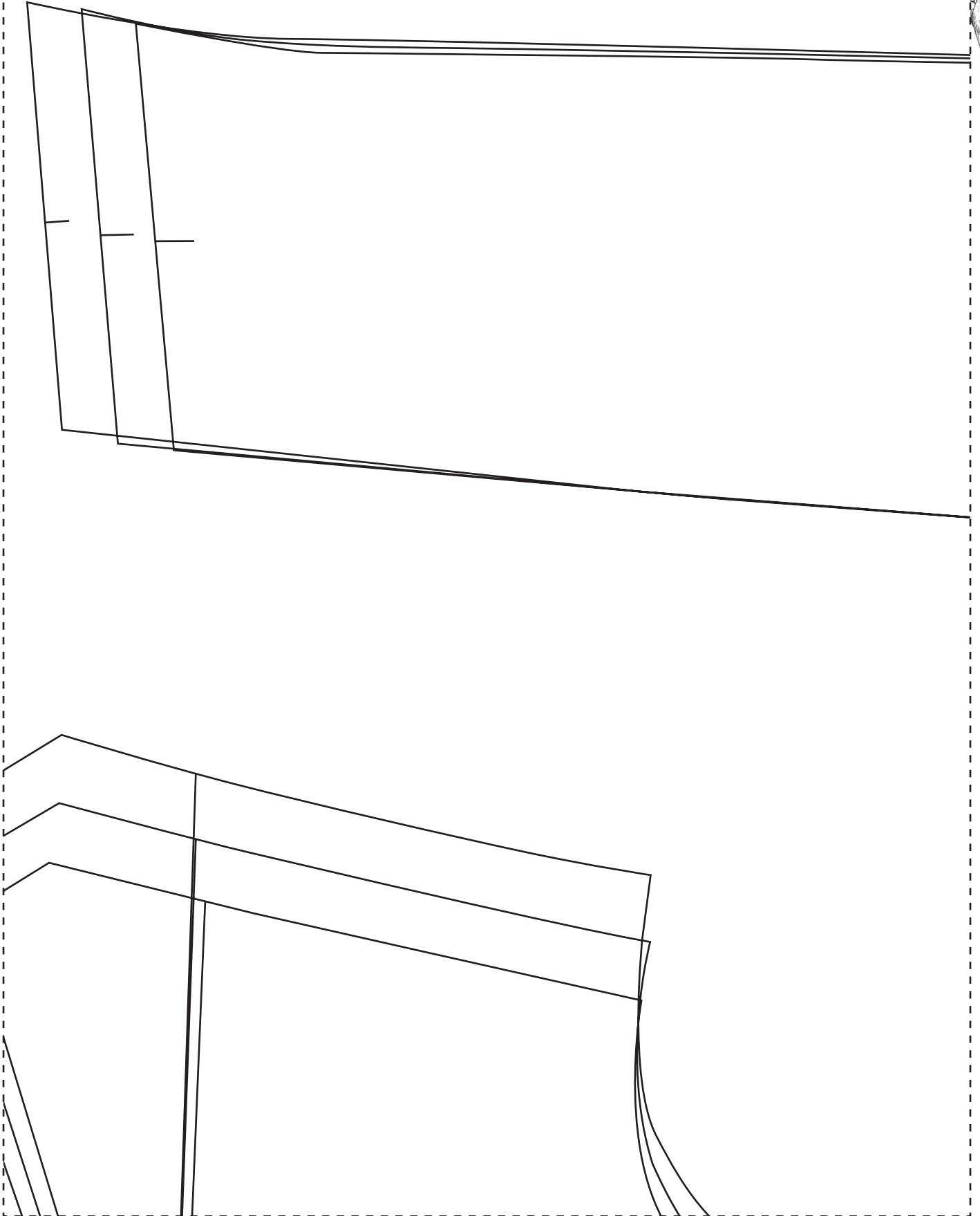

3



FRONT FACING
CUT X 1 PAIR
&
1 PAIR INTERFACING

4

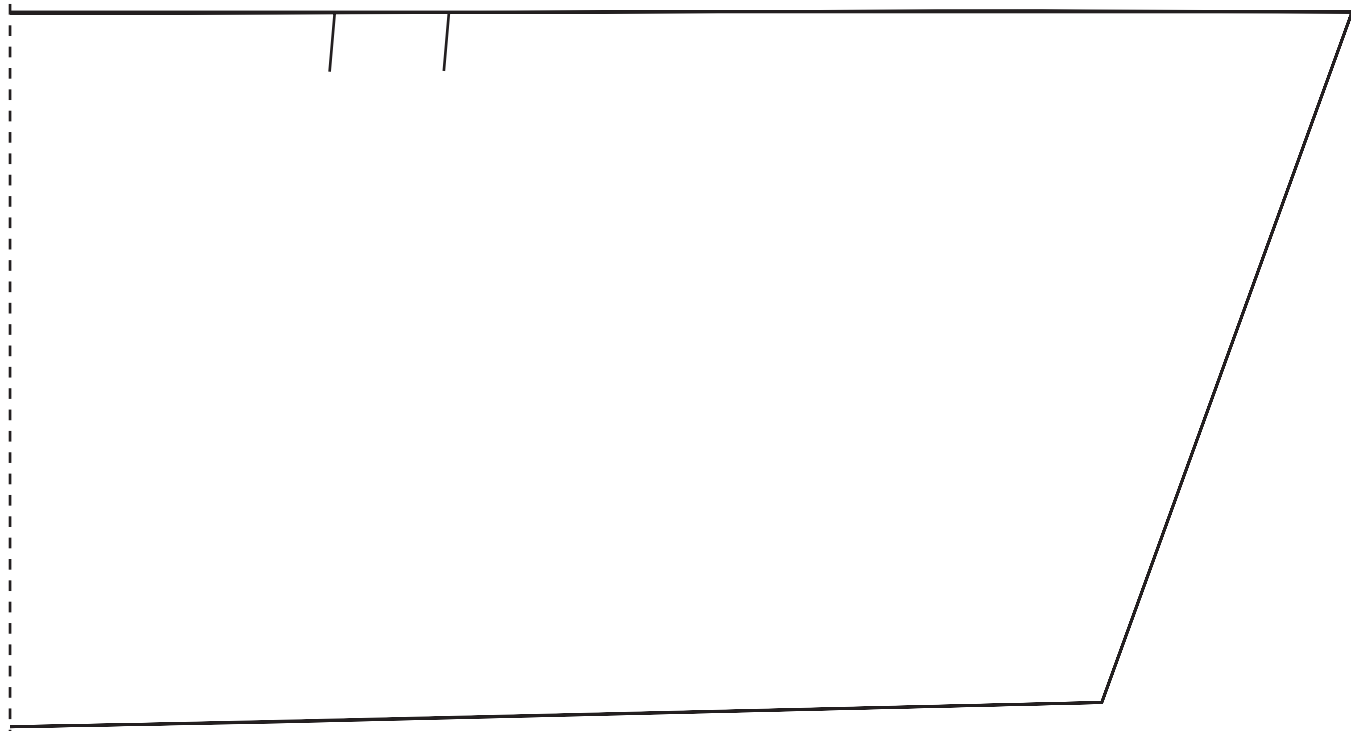

5

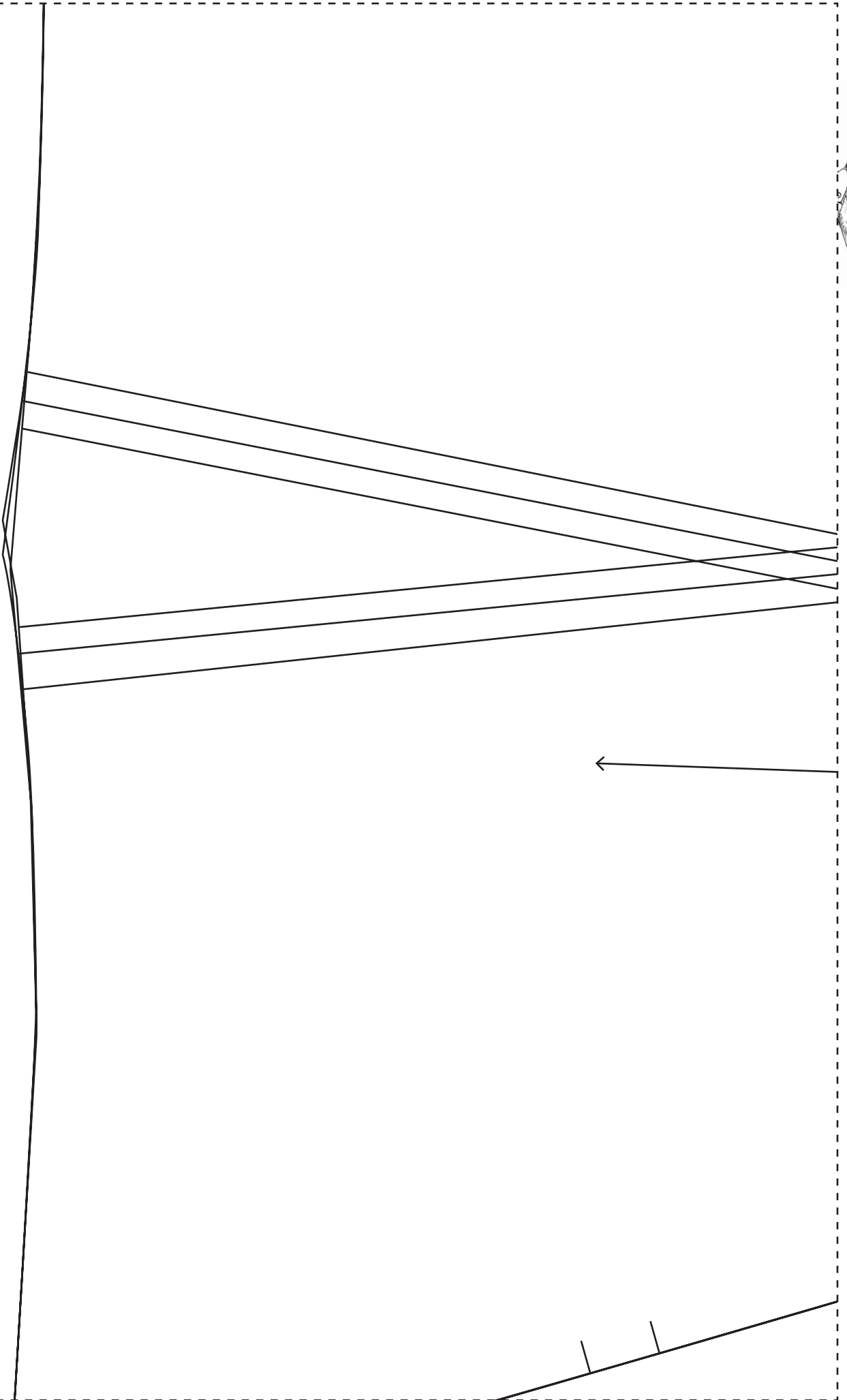

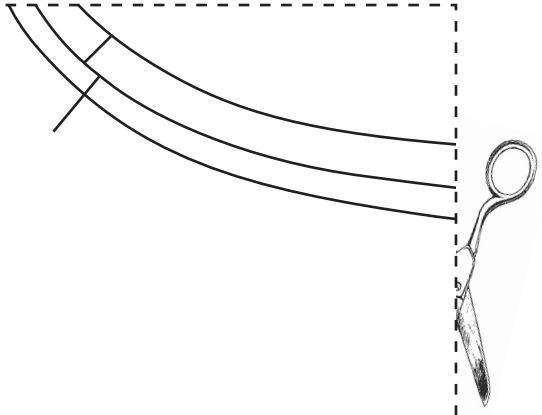

FRONT
CUT X 1 PAIR

6

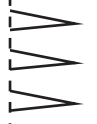

7

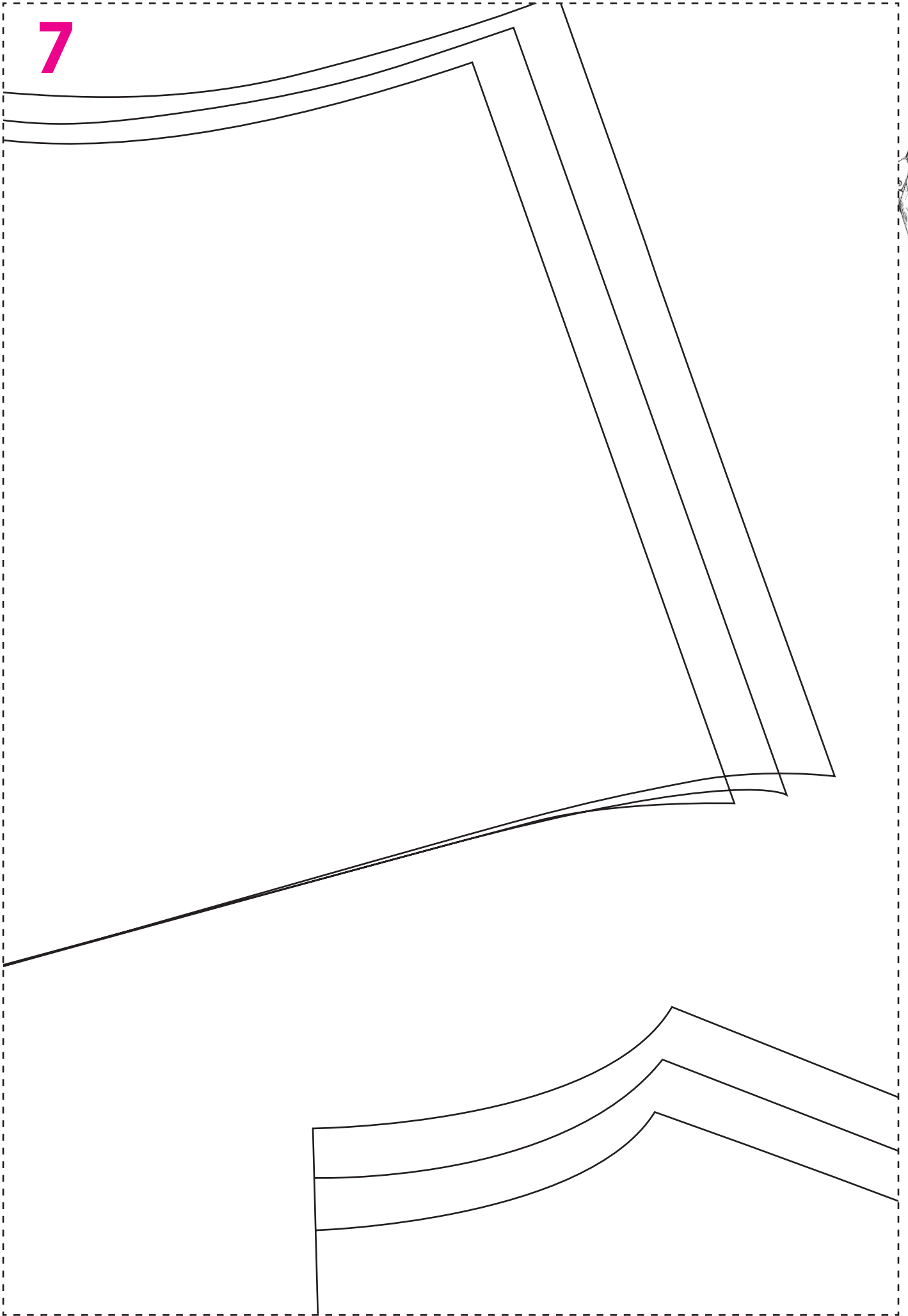

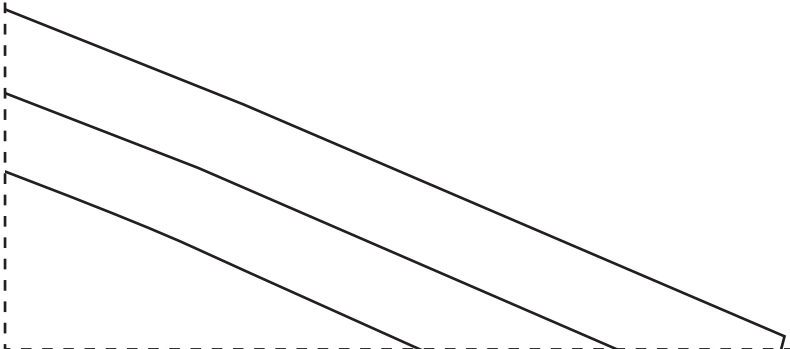
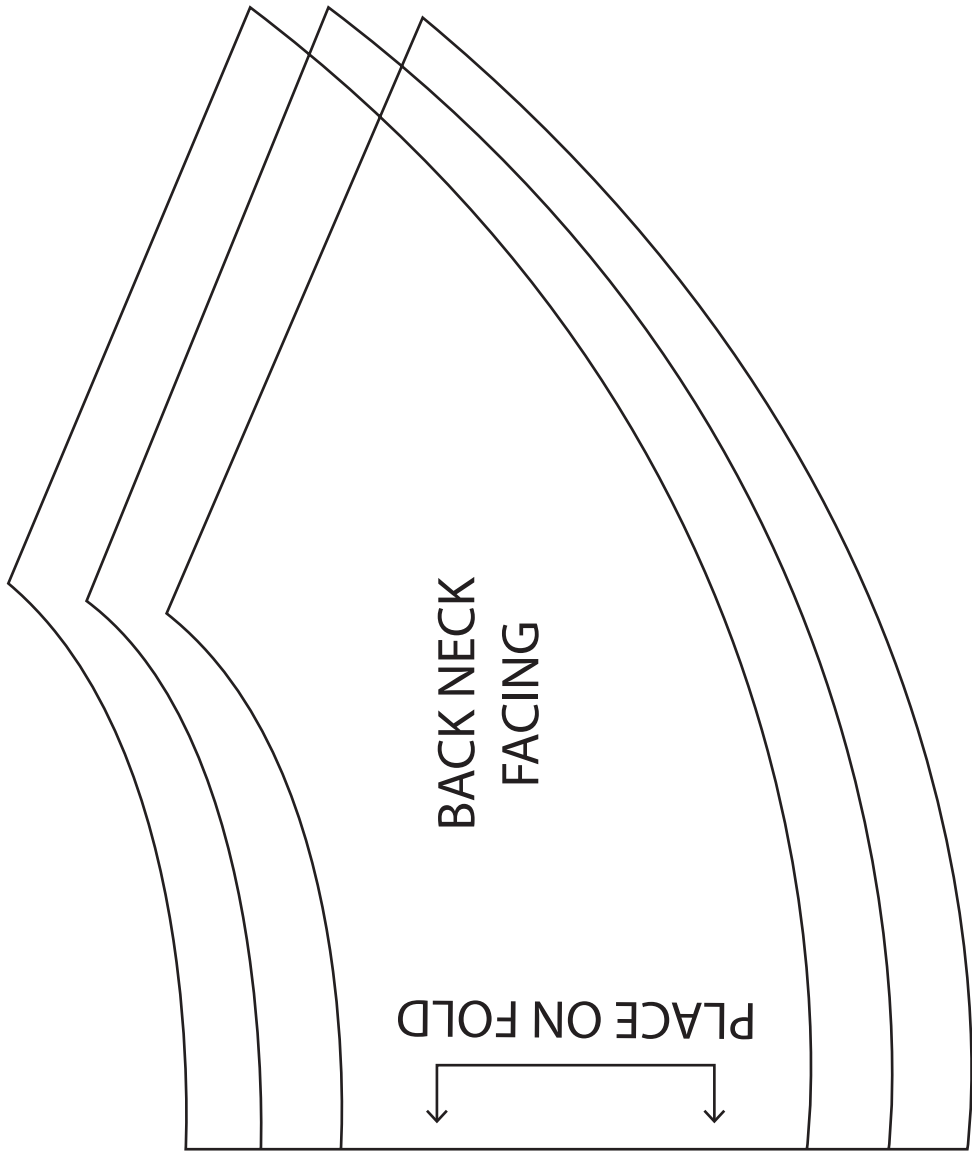

9

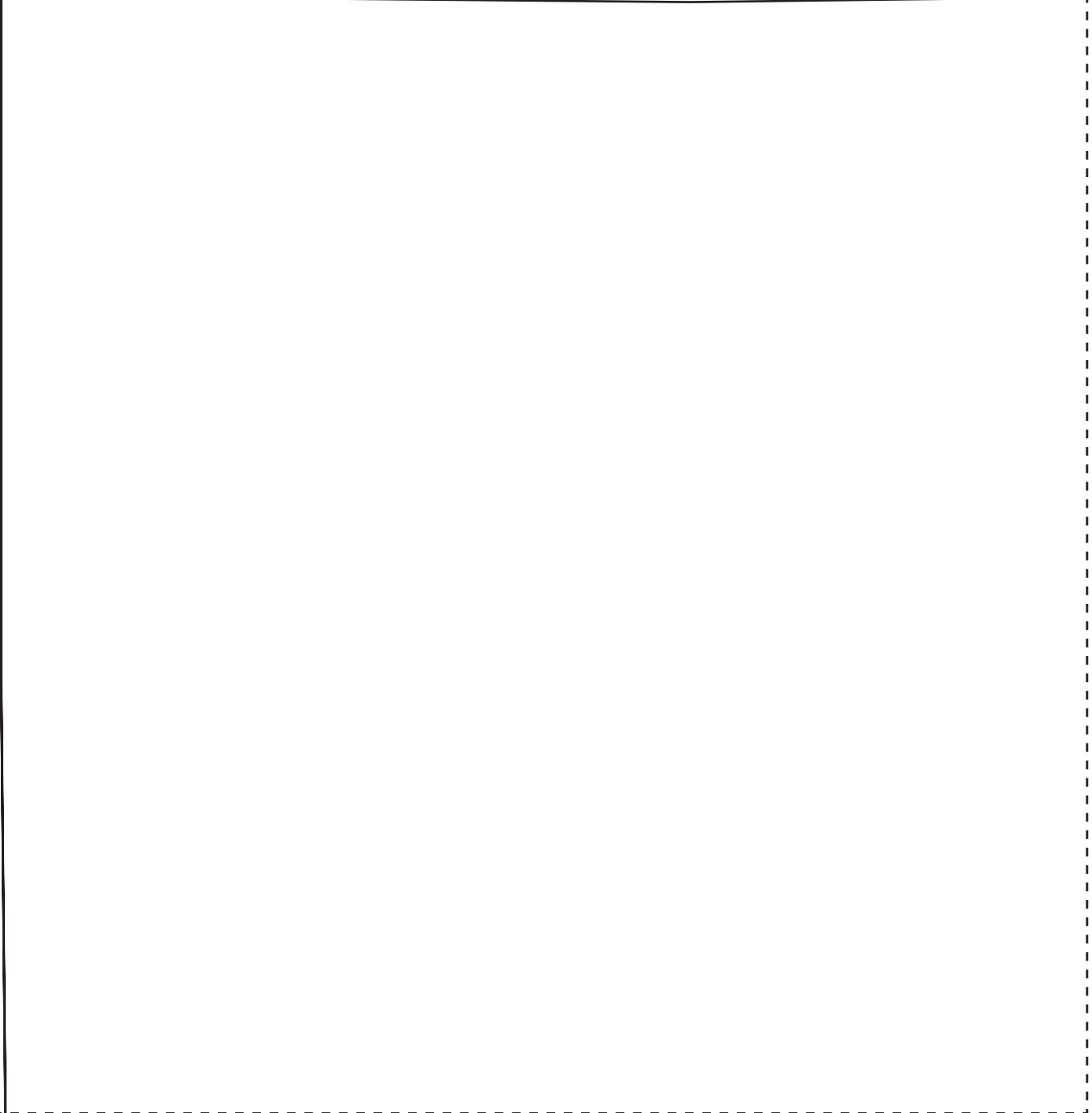
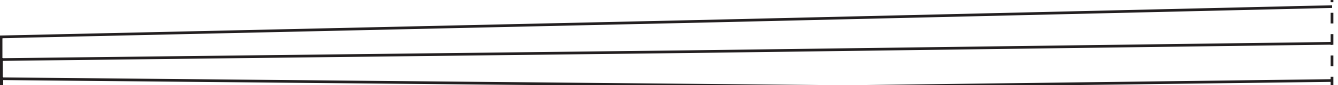
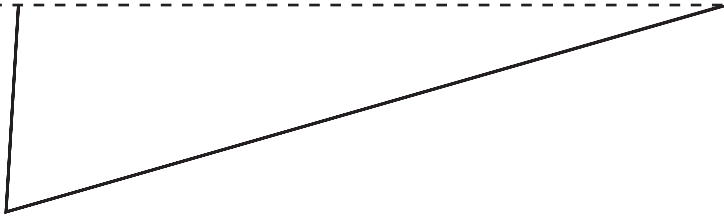

10

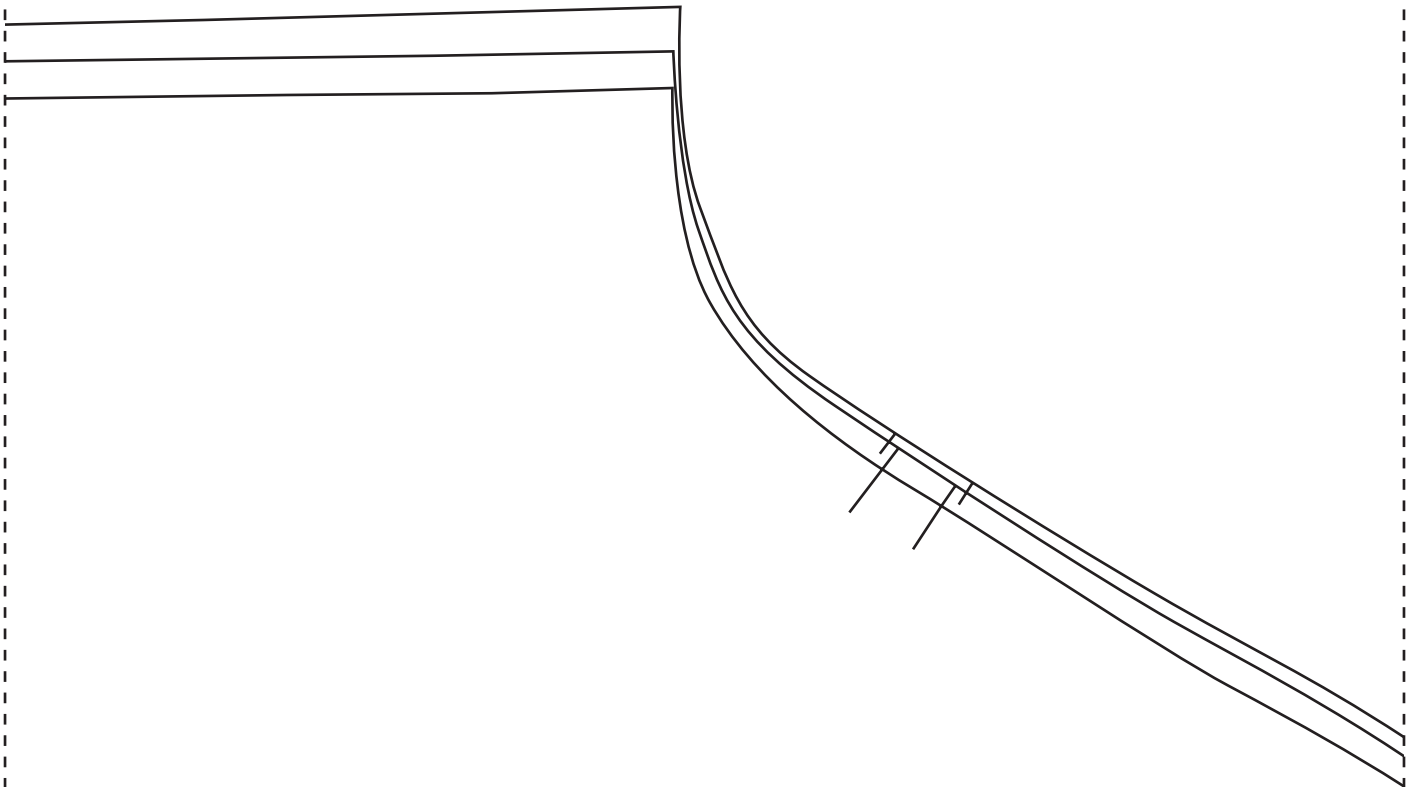

SLEEVE
CUT X 1 PAIR

11



PLACE ON FOLD

BACK
CUT X 1 ON FOLD

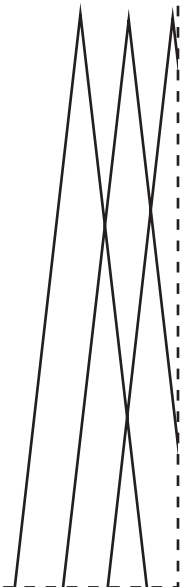
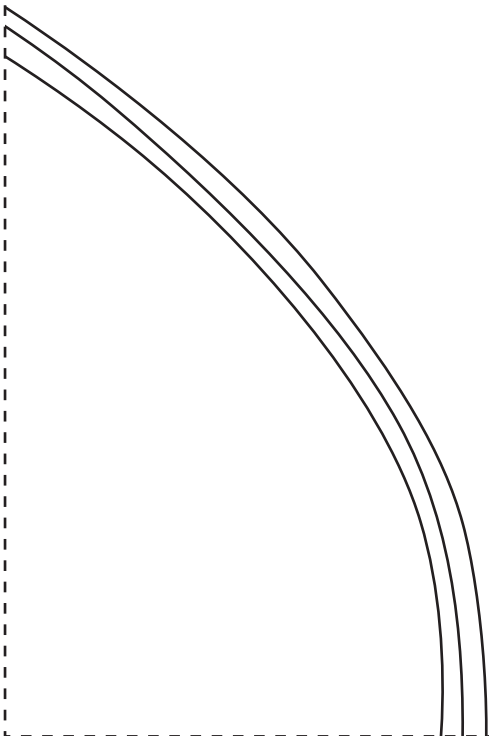

12

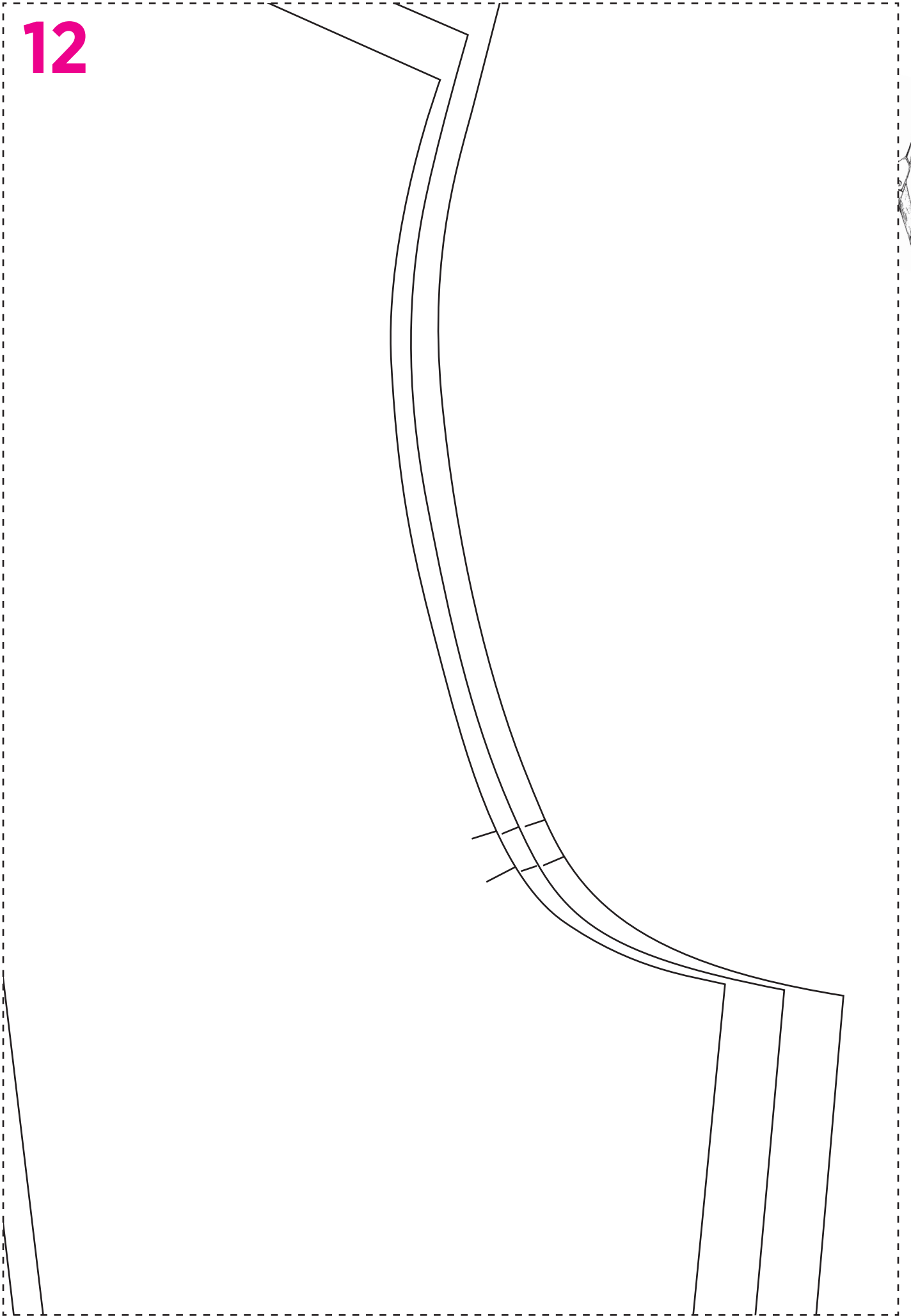

13

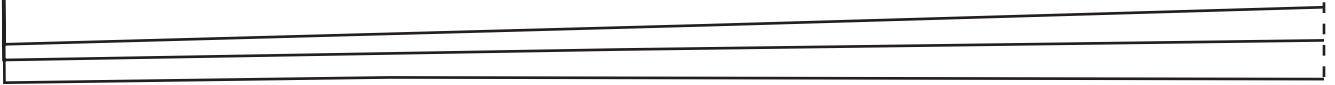
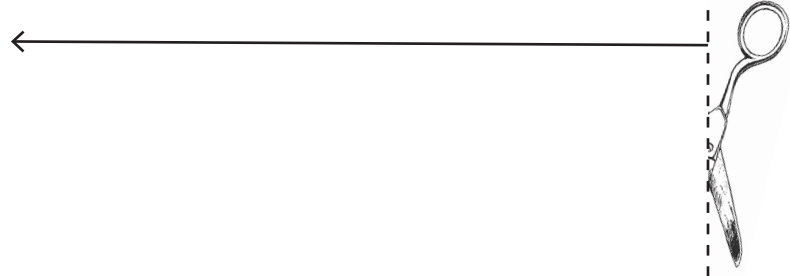

14

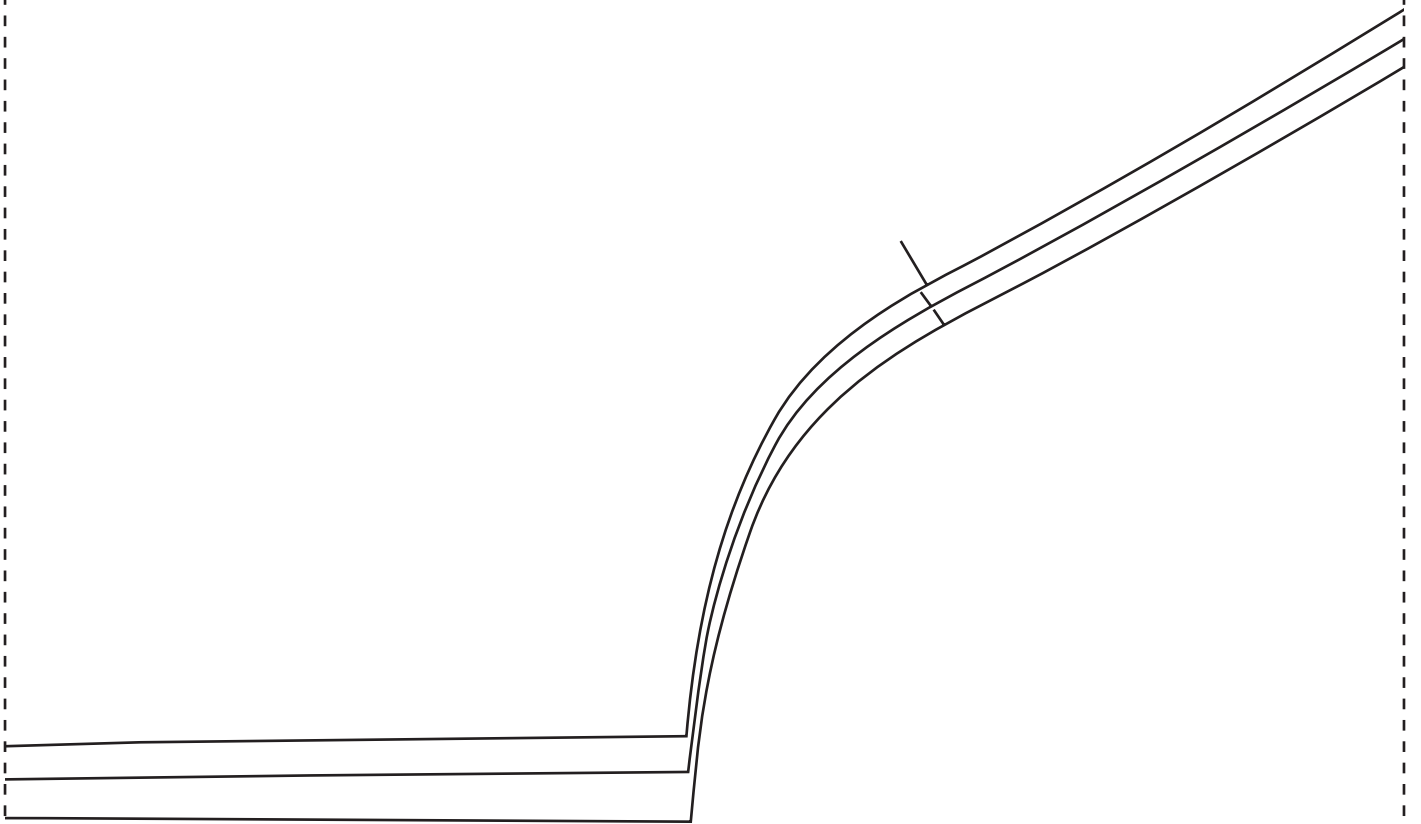

15

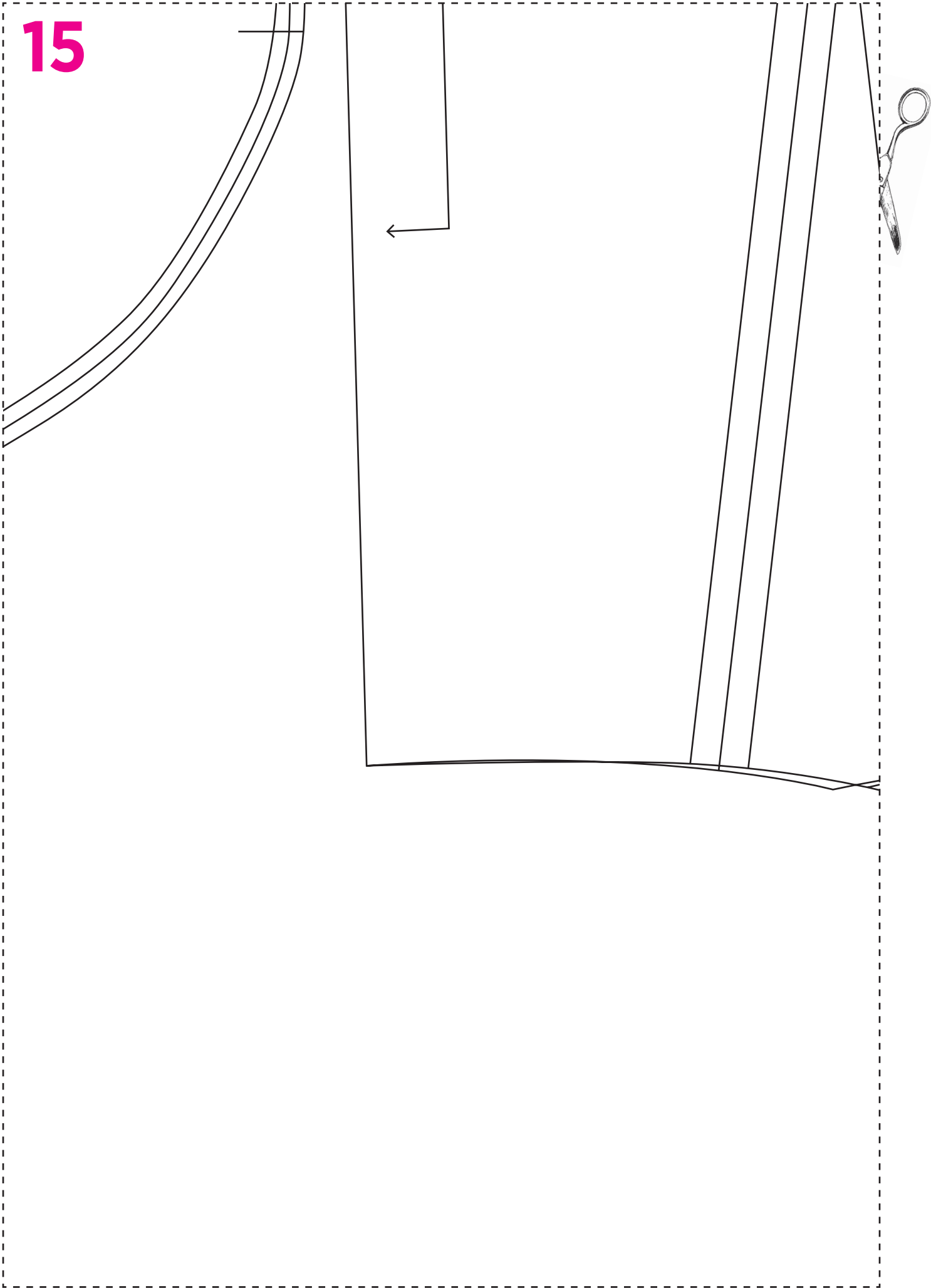

16

