

PINAFORE DRESS

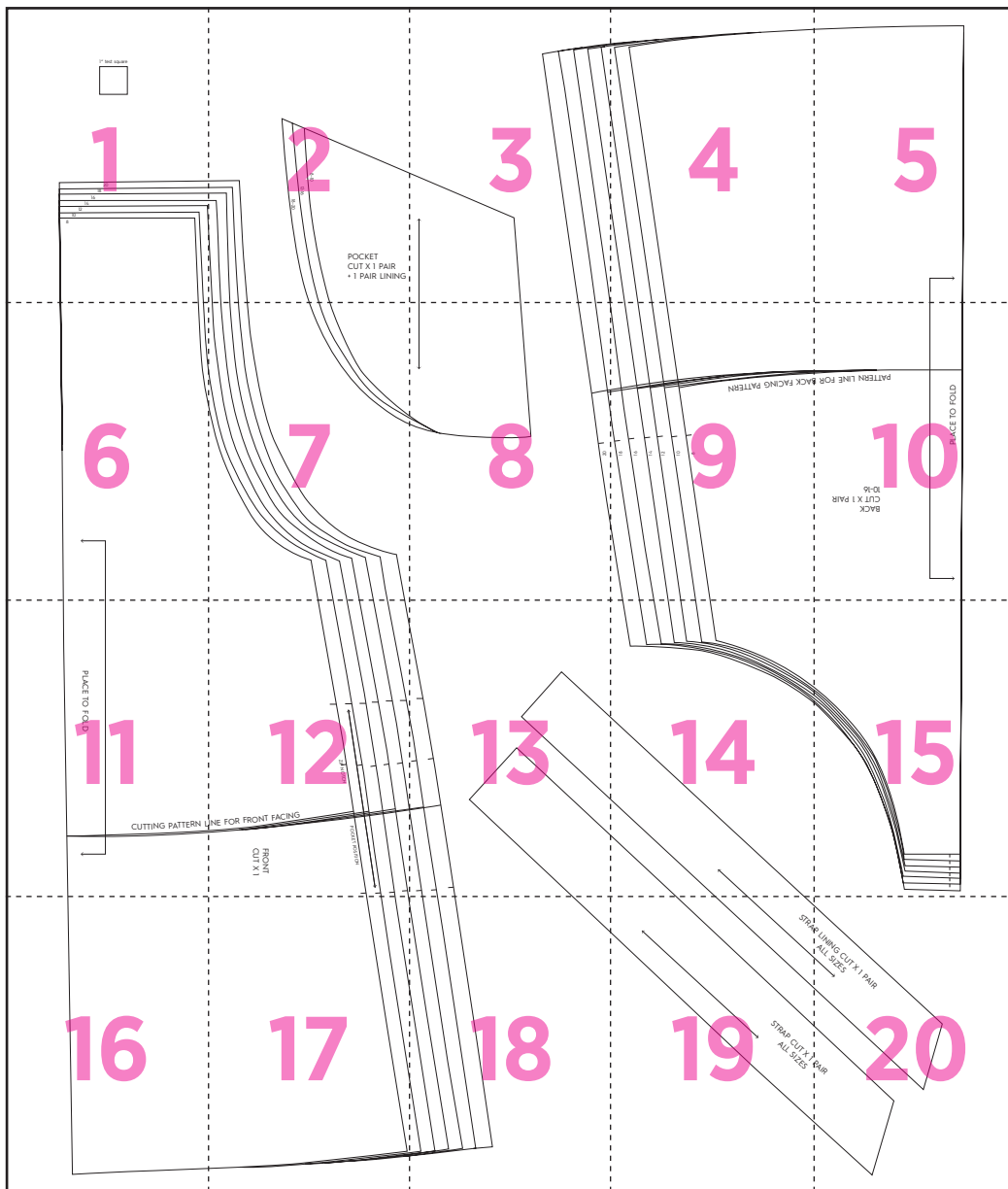

1



1" test square

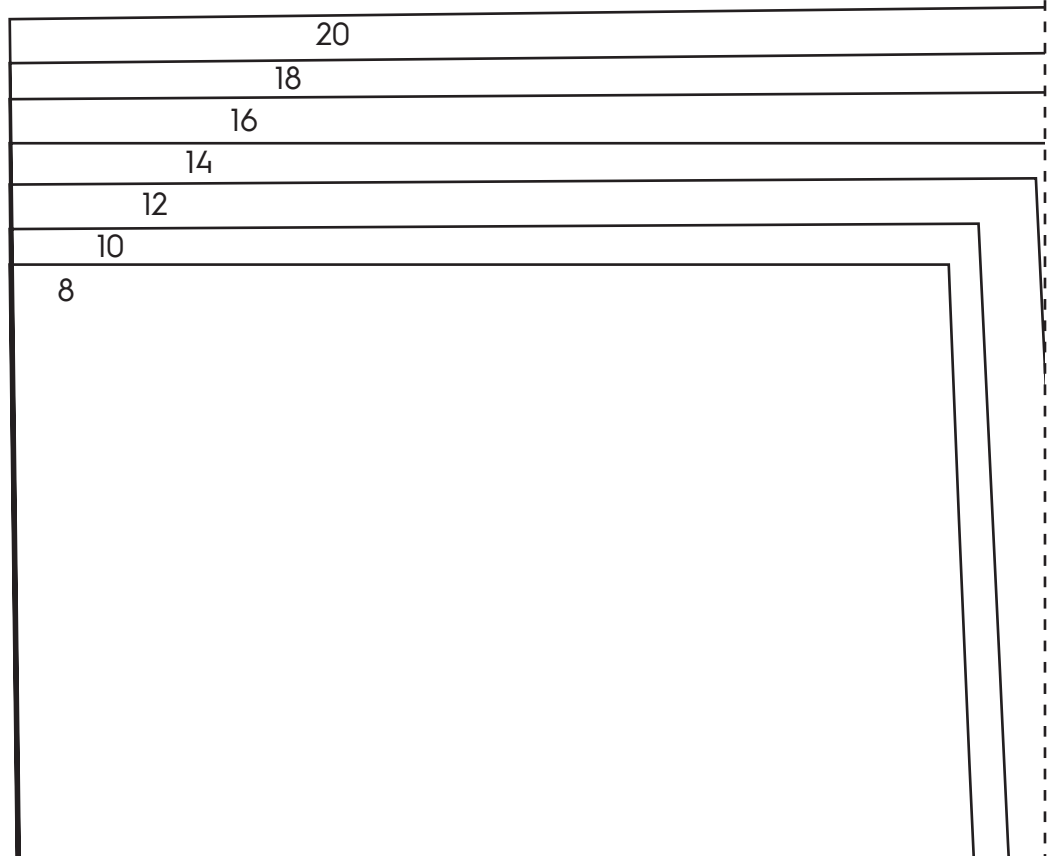
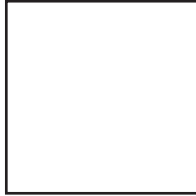

2

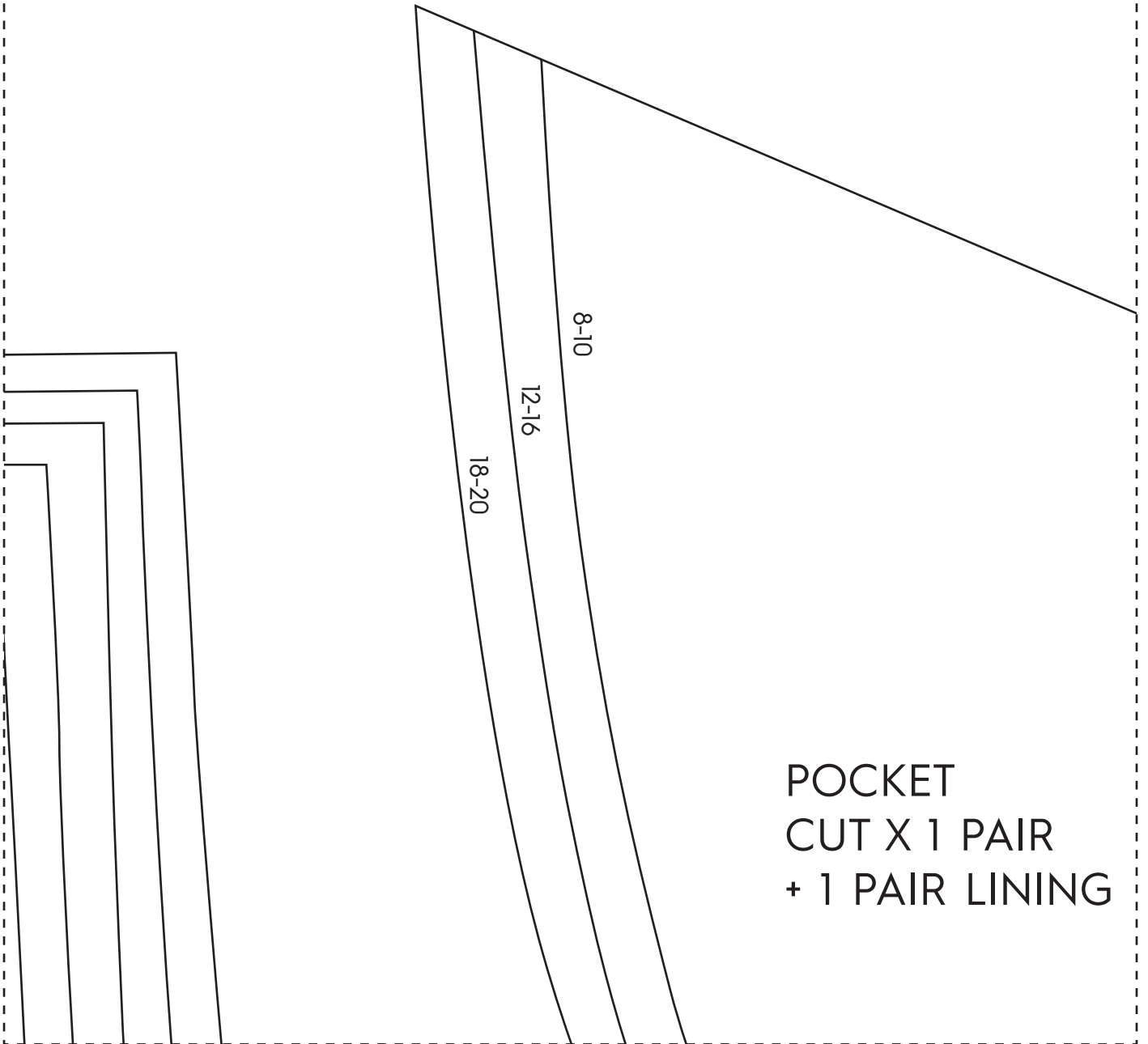

POCKET
CUT X 1 PAIR
+ 1 PAIR LINING

3

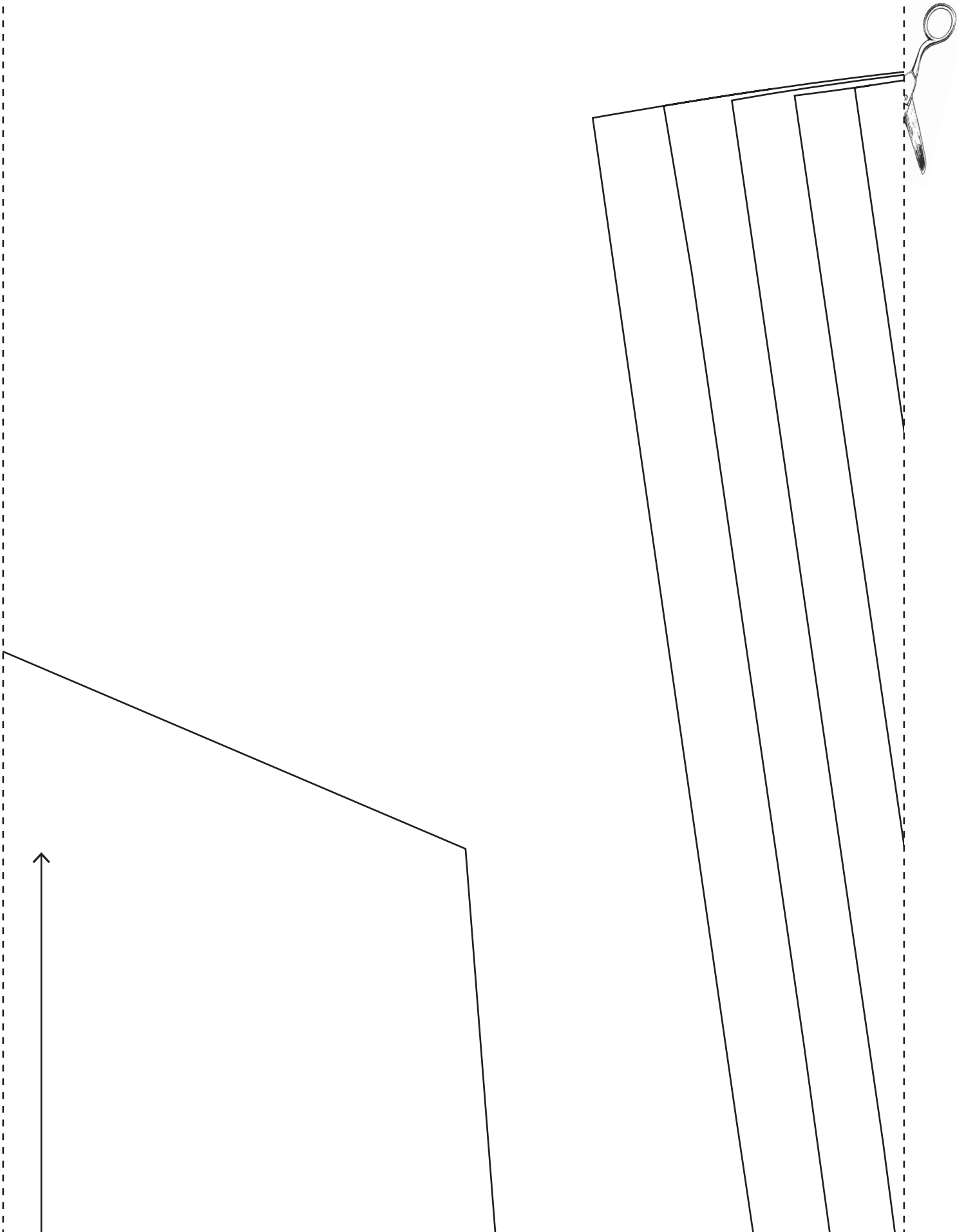

4

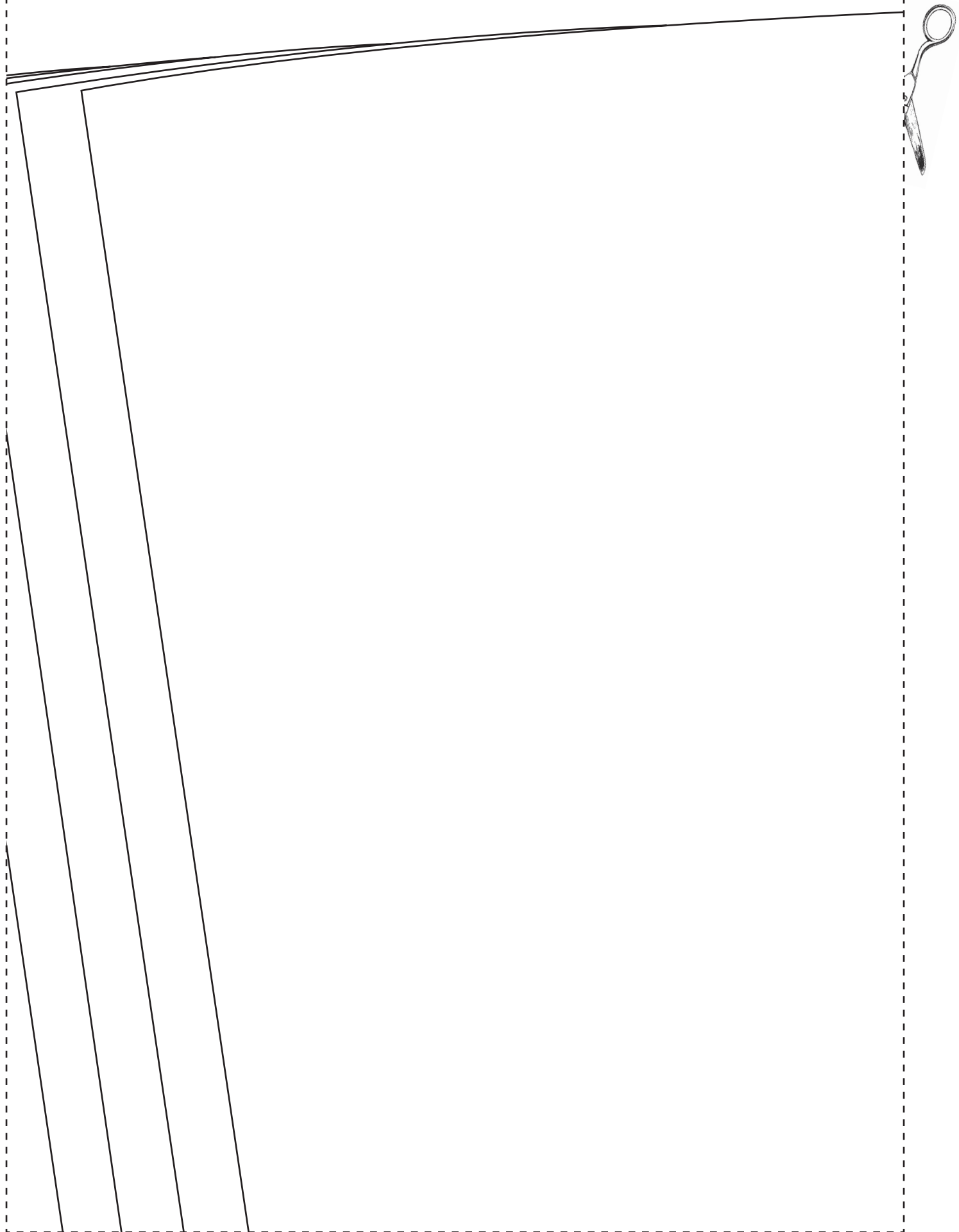

5

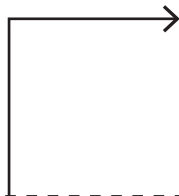

6



7

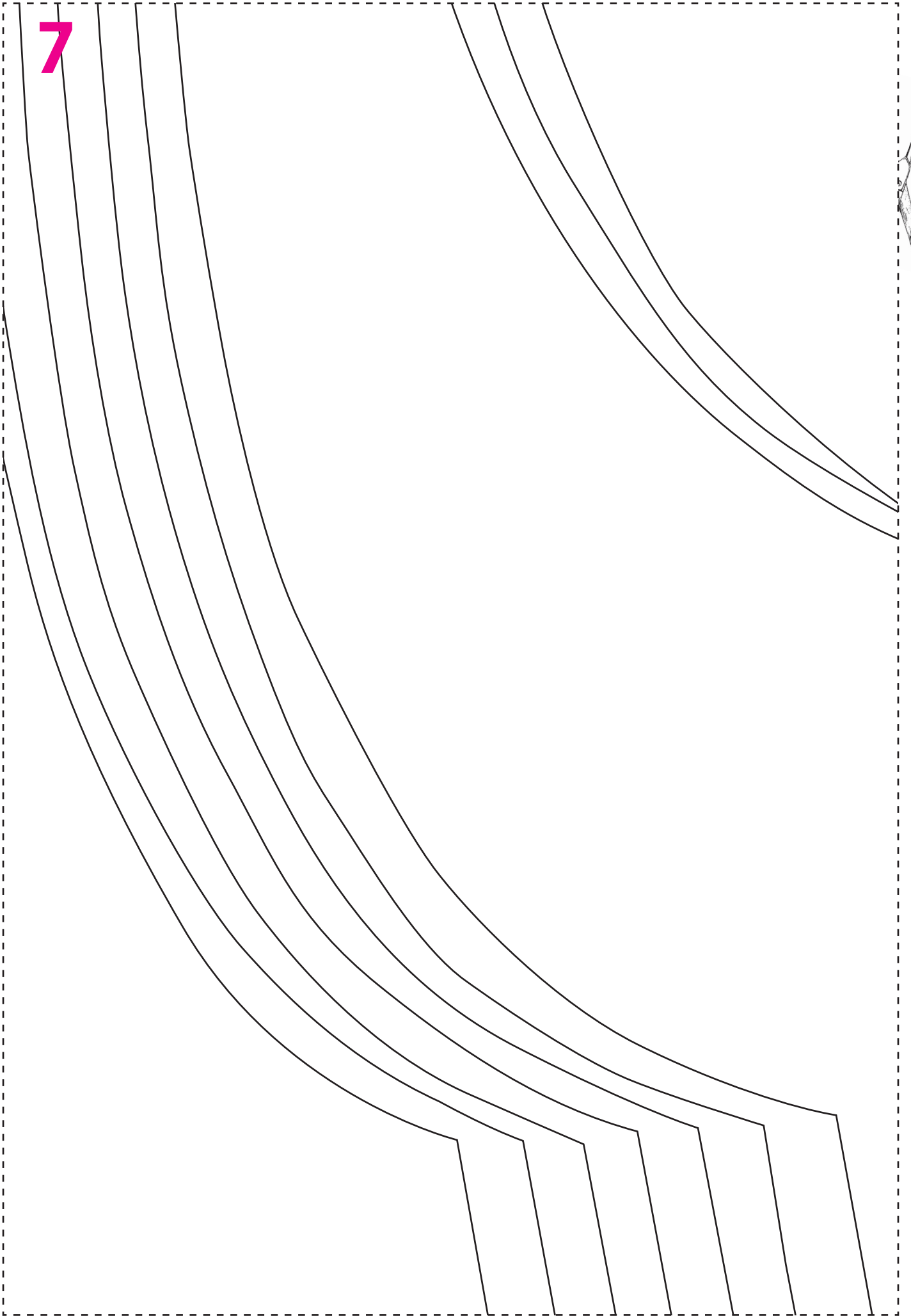

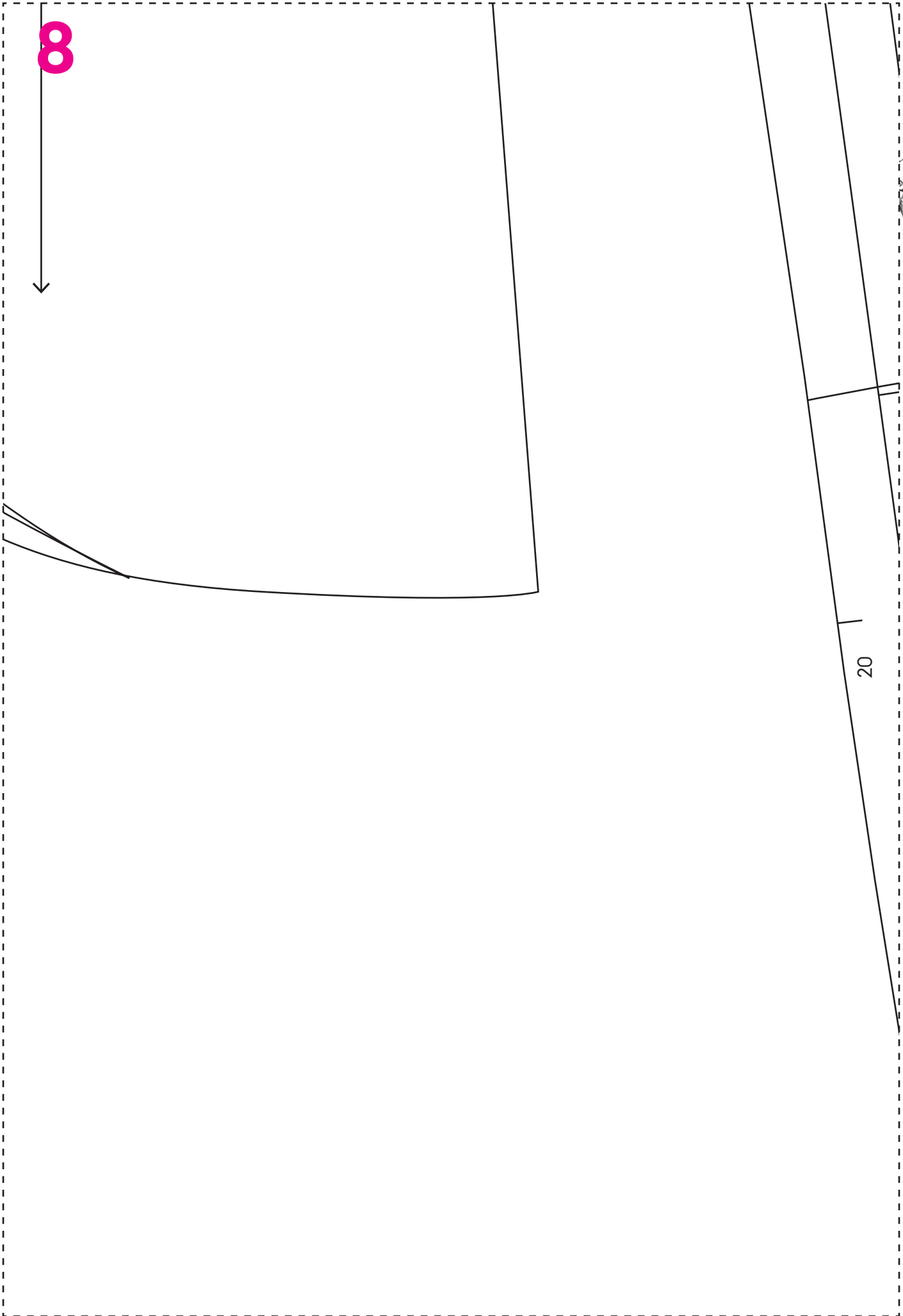

8



20

9

BACK FACING PATTERN

18

16

14

12

10

8



10

PATTERN LINE FOR F

BACK
CUT X 1 PAIR
10-16

PLACE TO FOLD



11

PLACE TO FOLD

CUTTING PATTERN L



12



LINE FOR FRONT FACING

FRONT
CUT X 1

ZIP NOTCH

POCKET POSITION

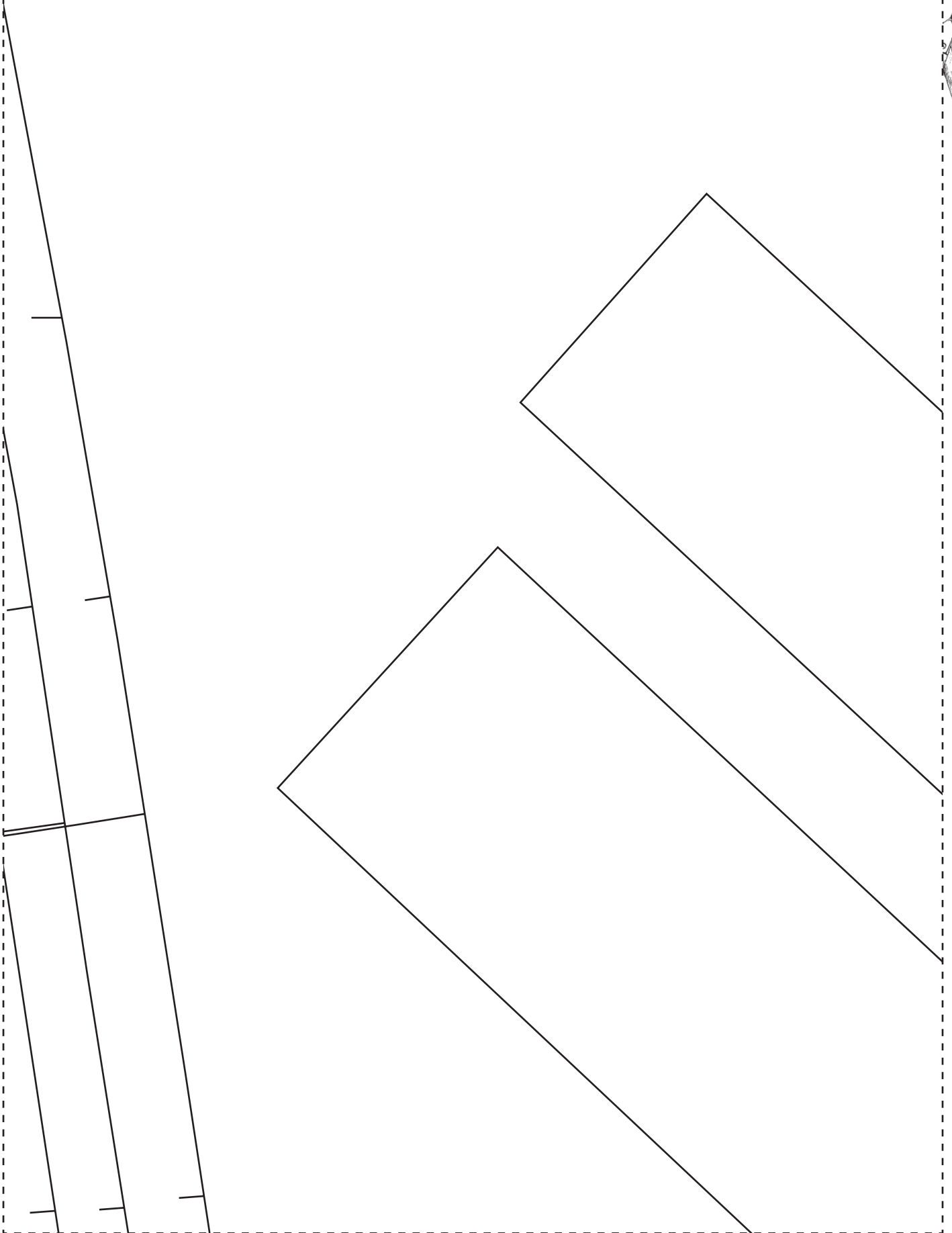

14

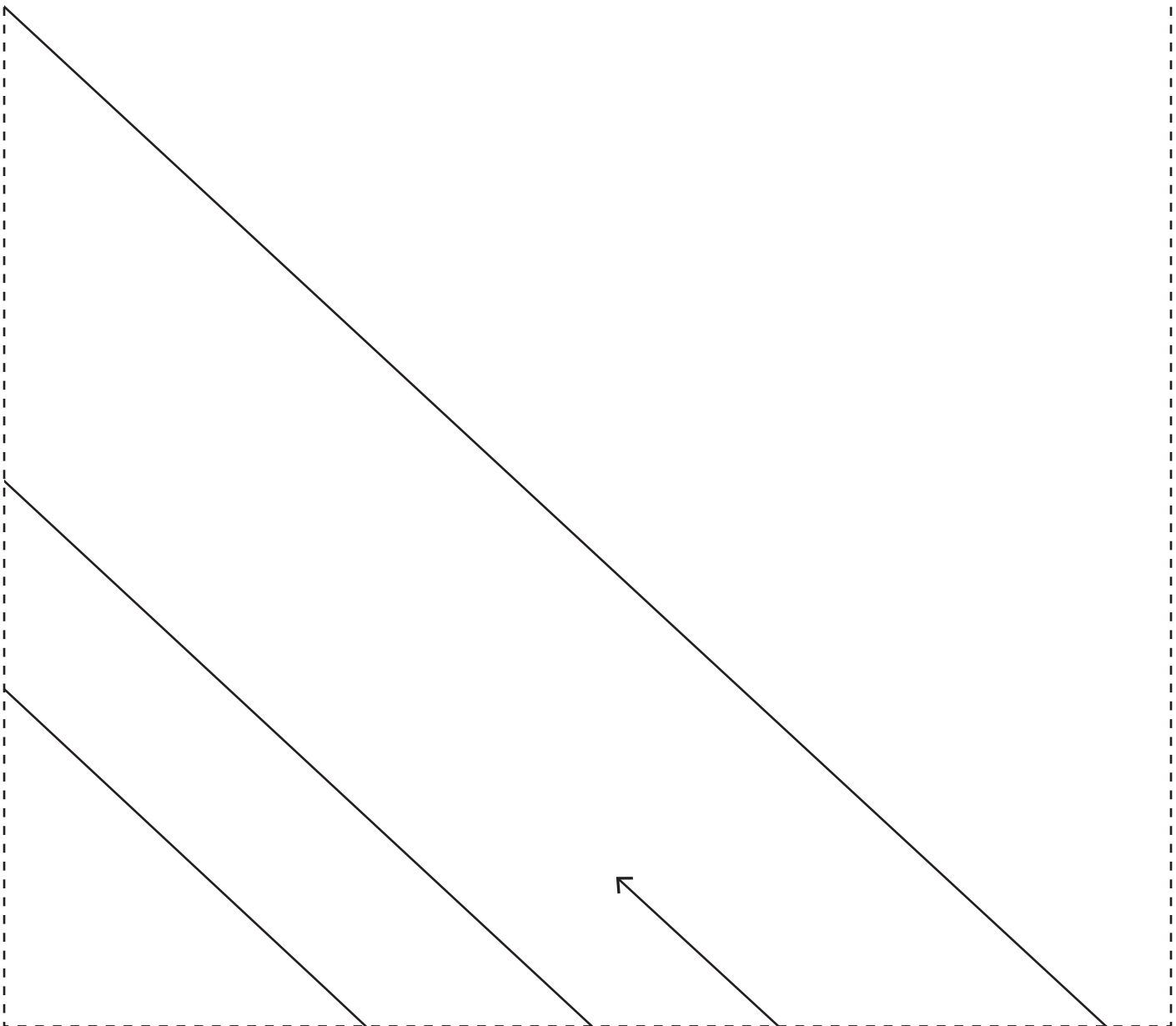

15

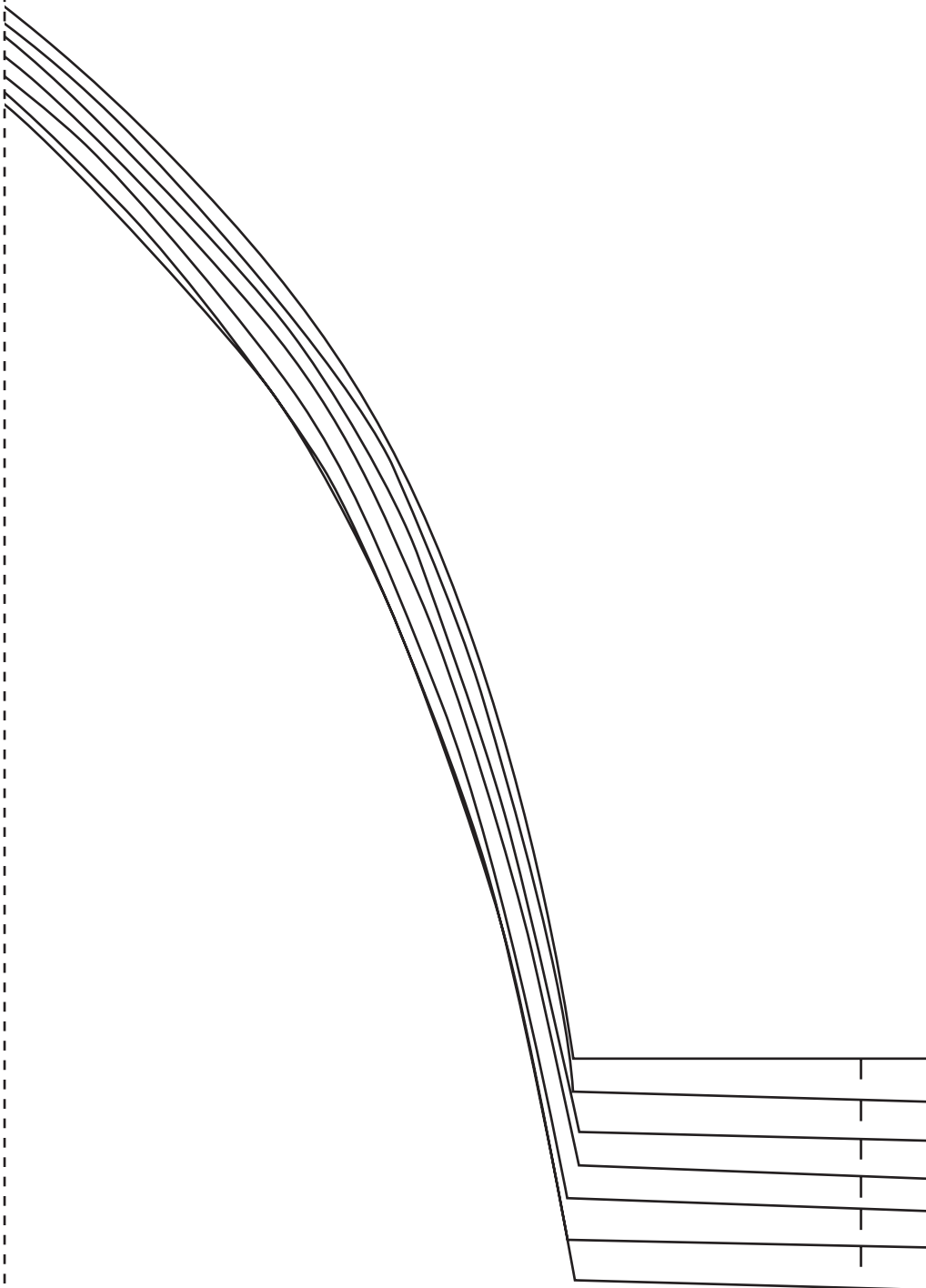

16



17

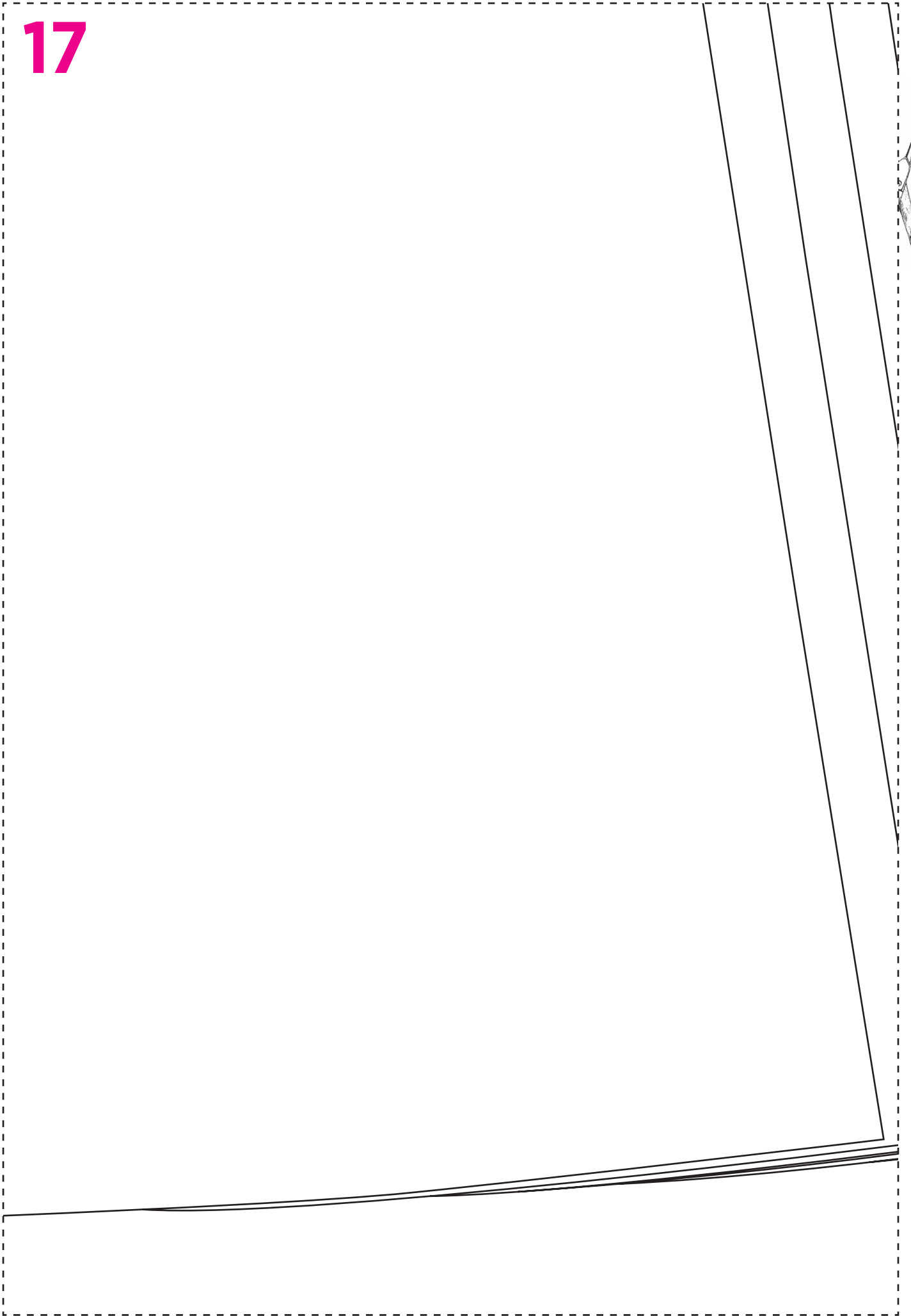

18

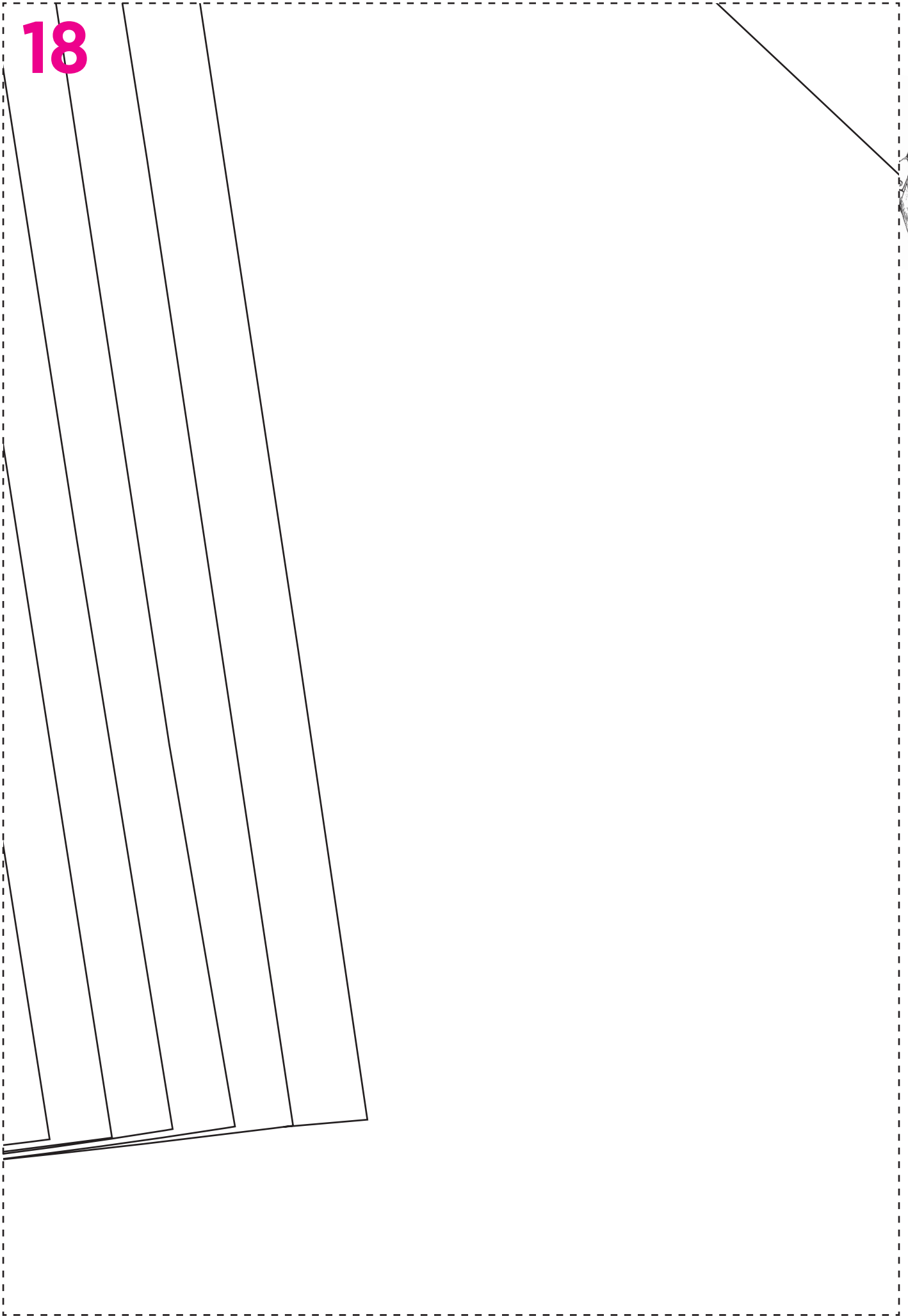

19

STRAP



STRAP CUT X 1
ALL SIZES

20

P LINING CUT X 1 PAIR
ALL SIZES



PAIR

