

MARINER'S COMPASS

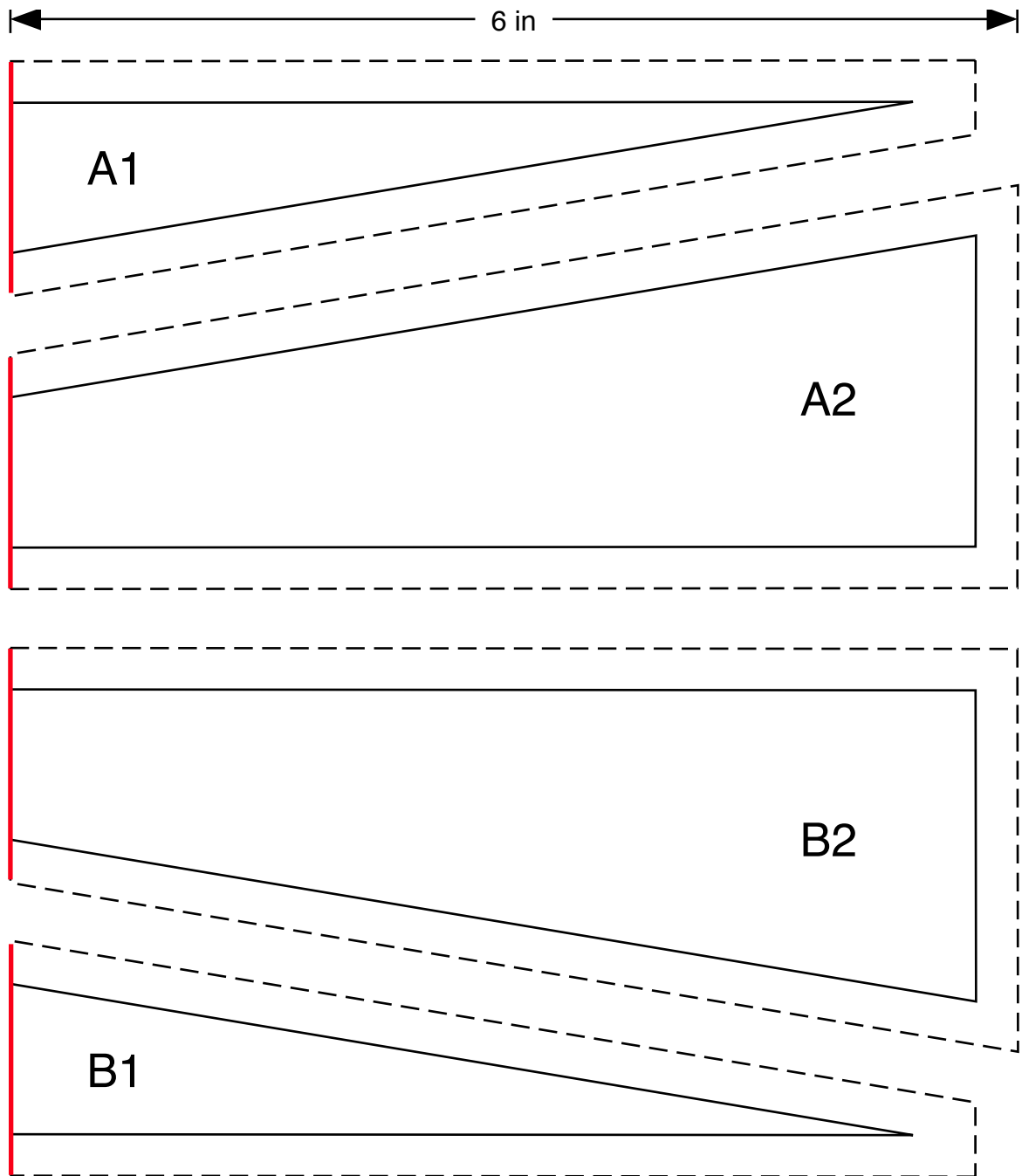

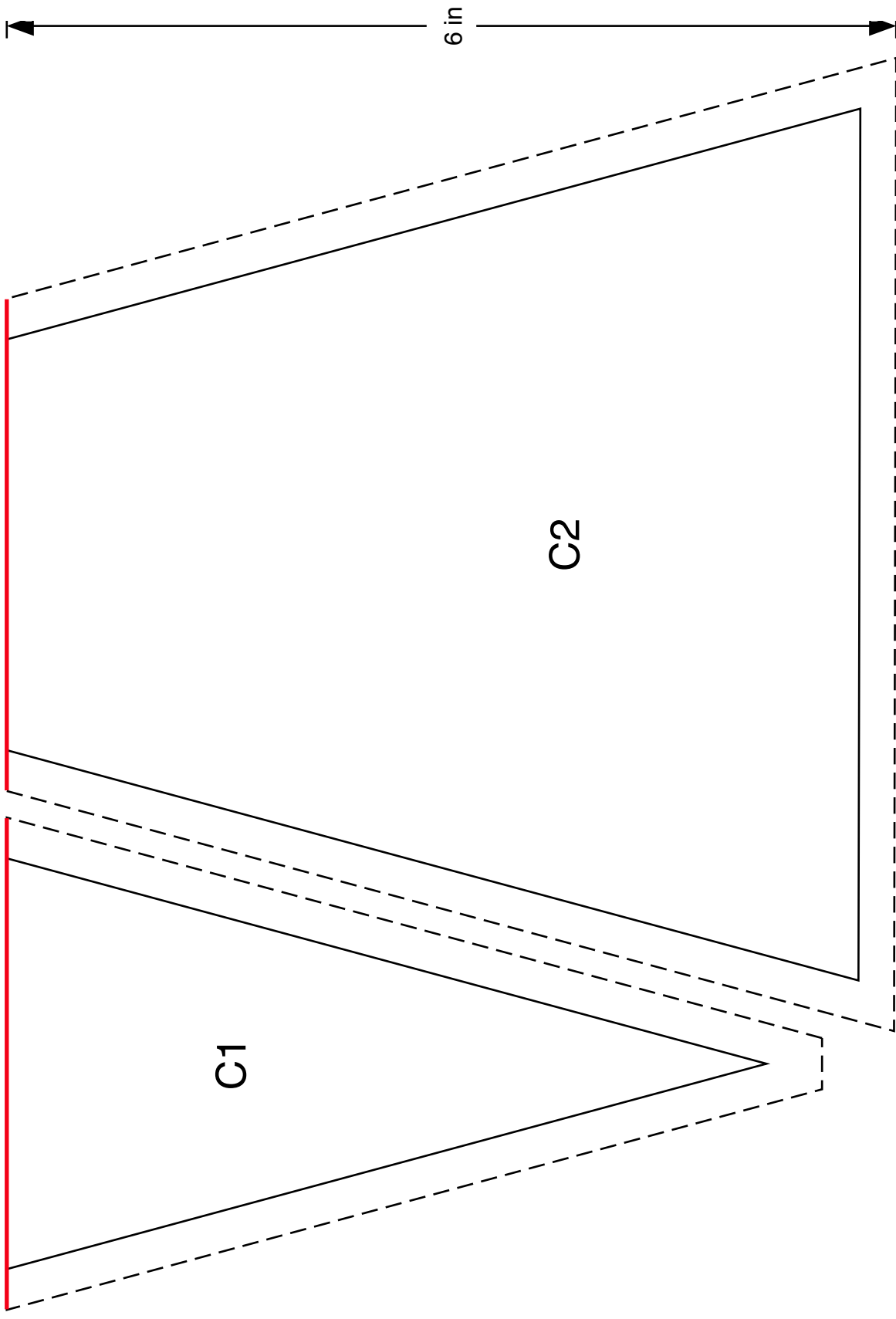

6 in

C2

C1

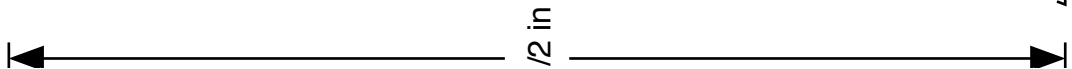
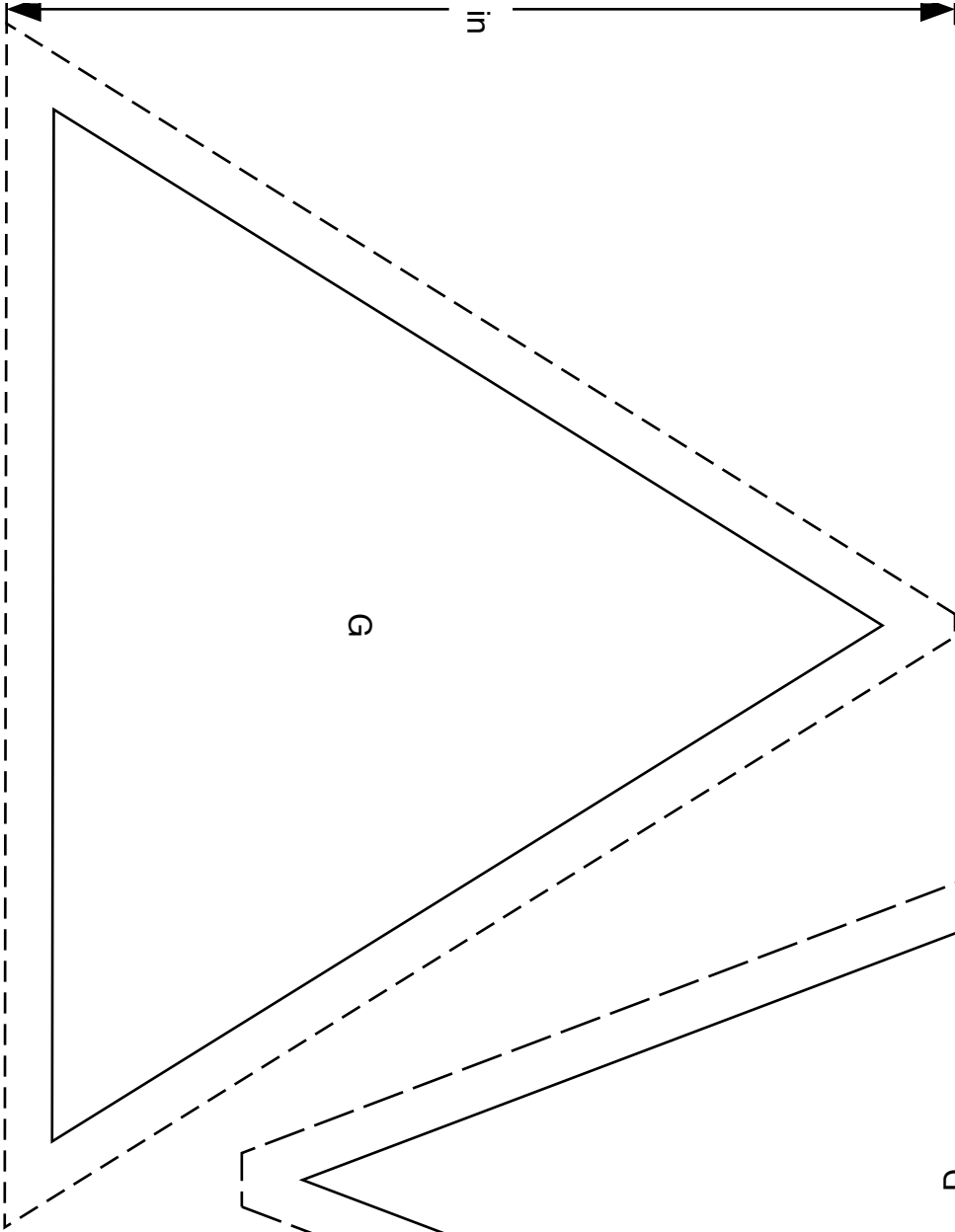

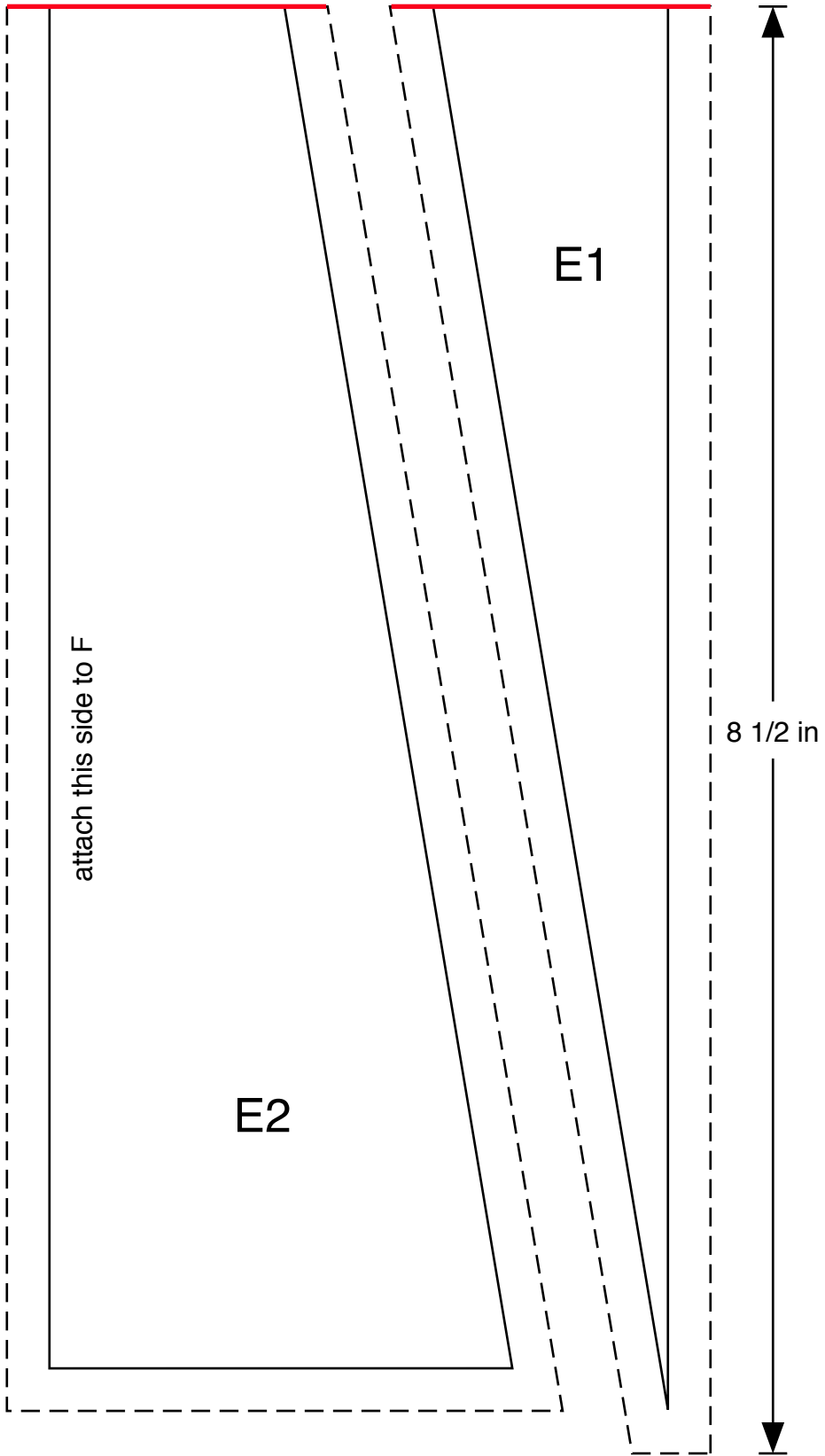

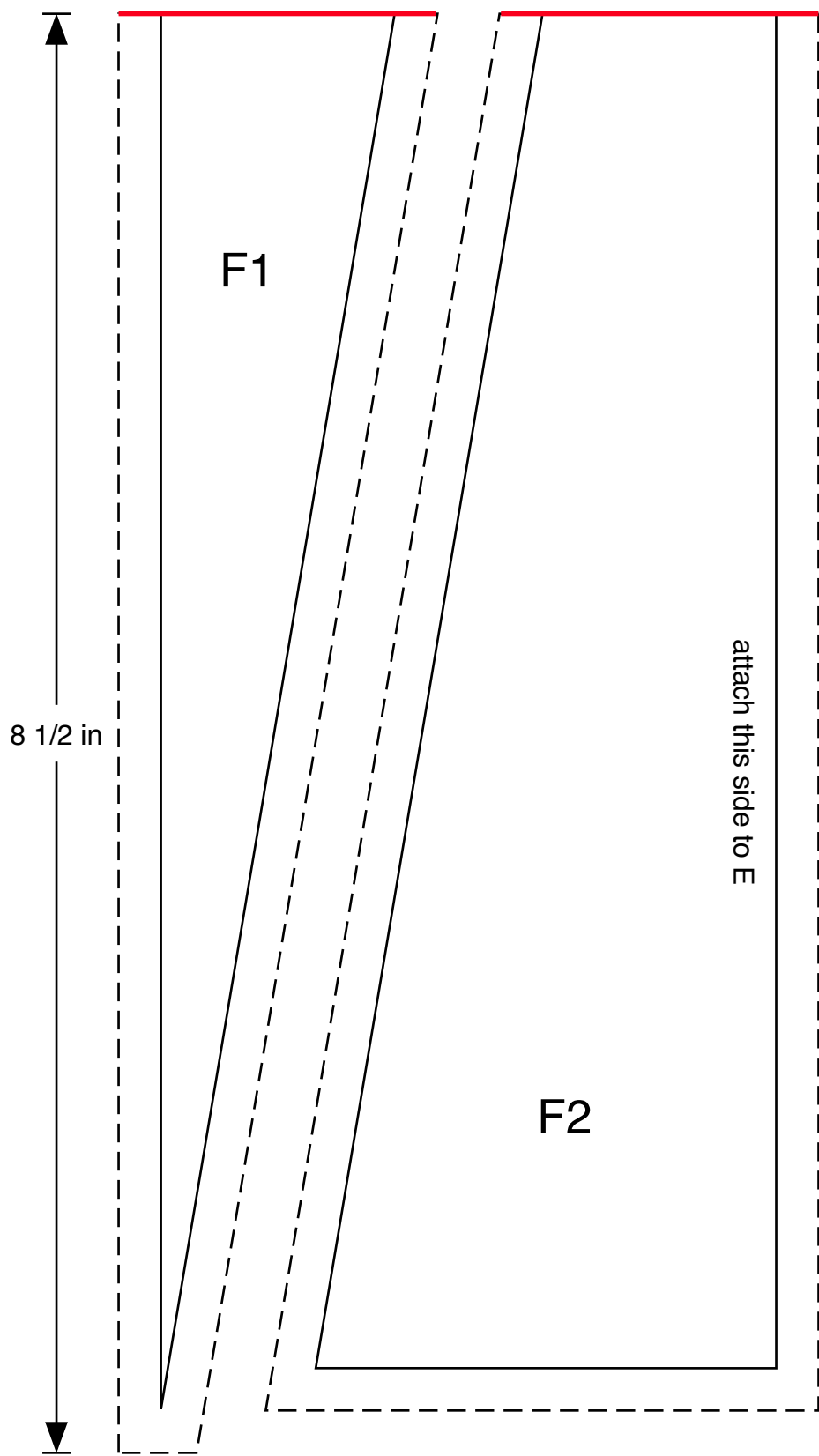

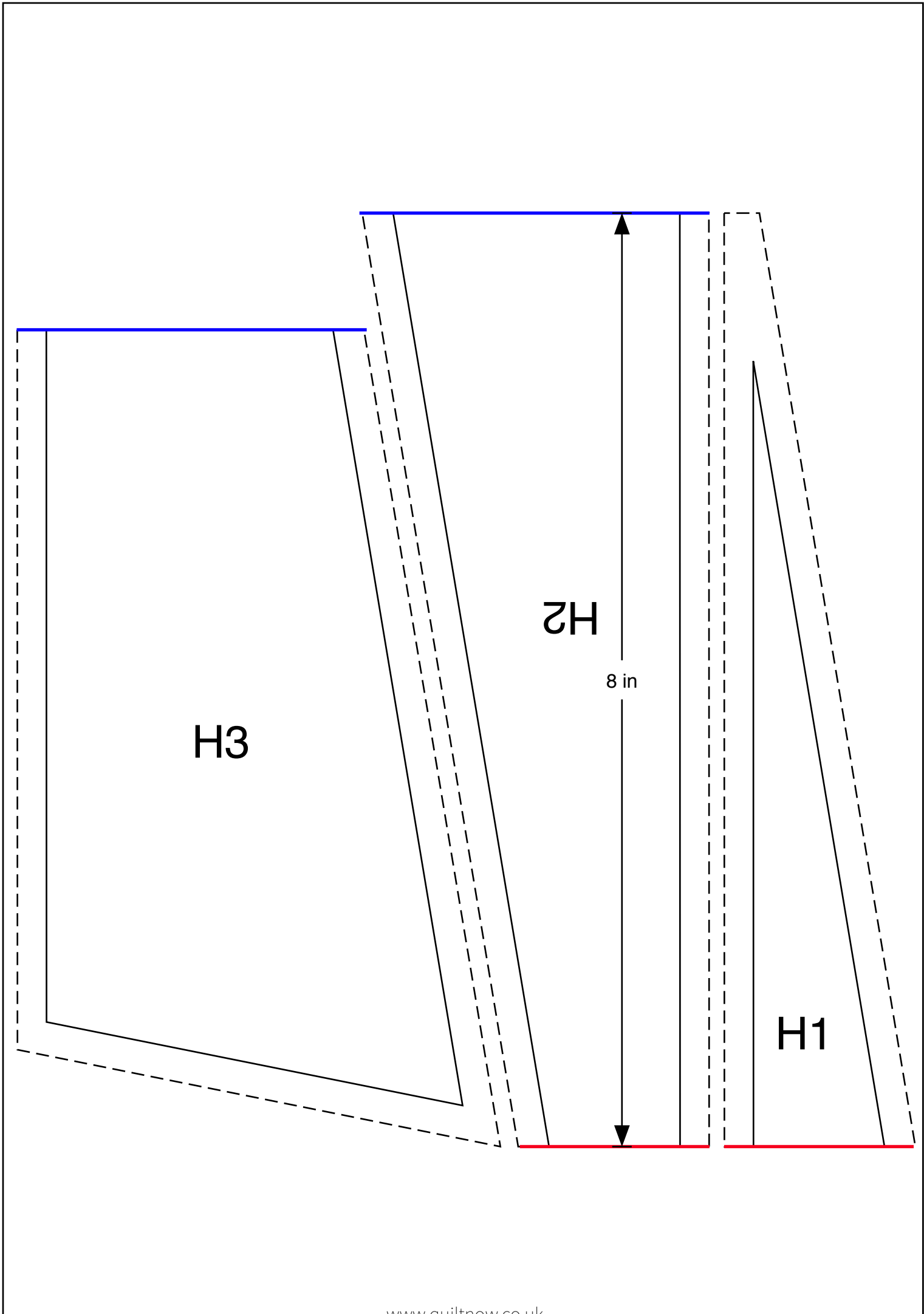

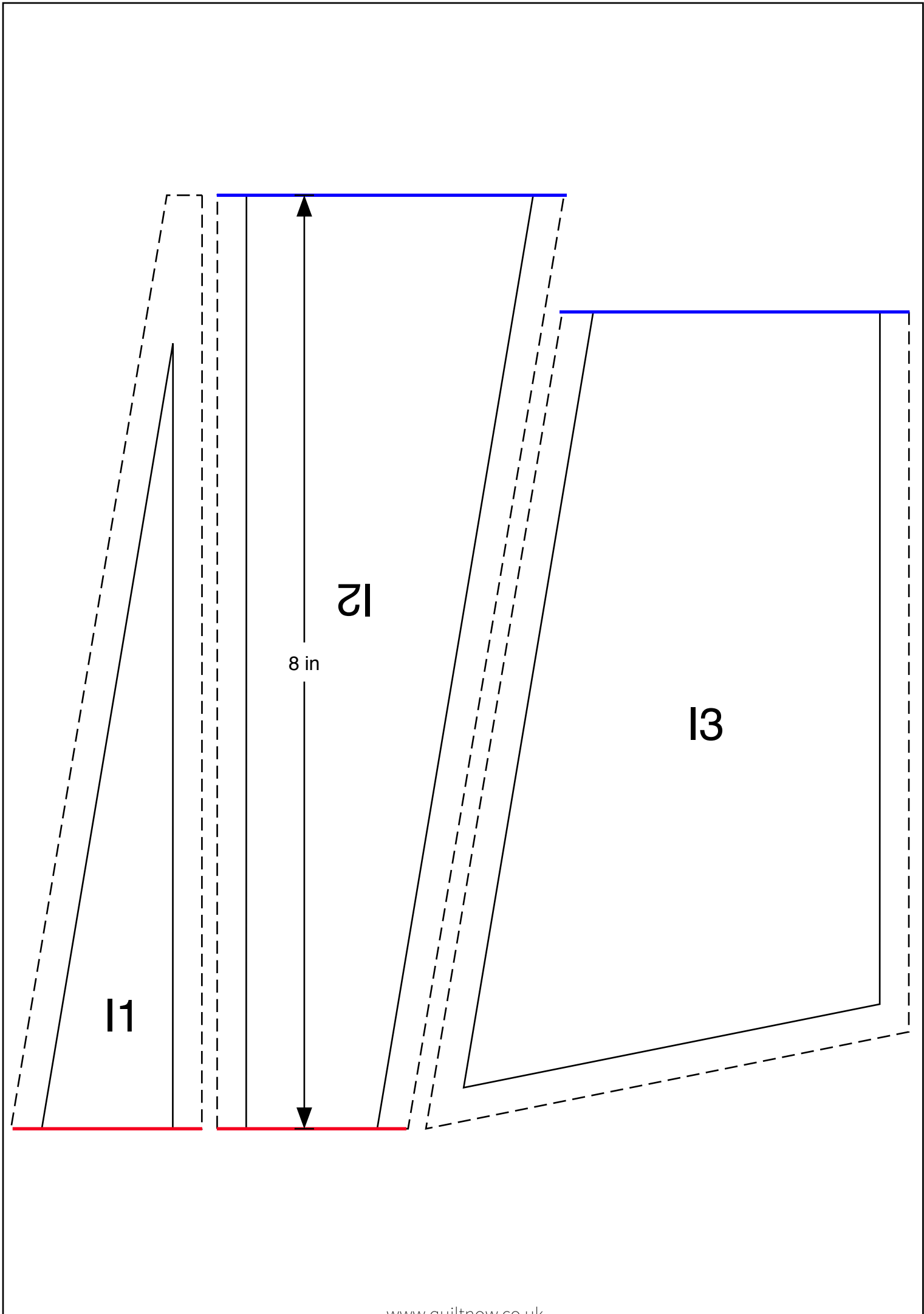

I1

I2

8 in

I3

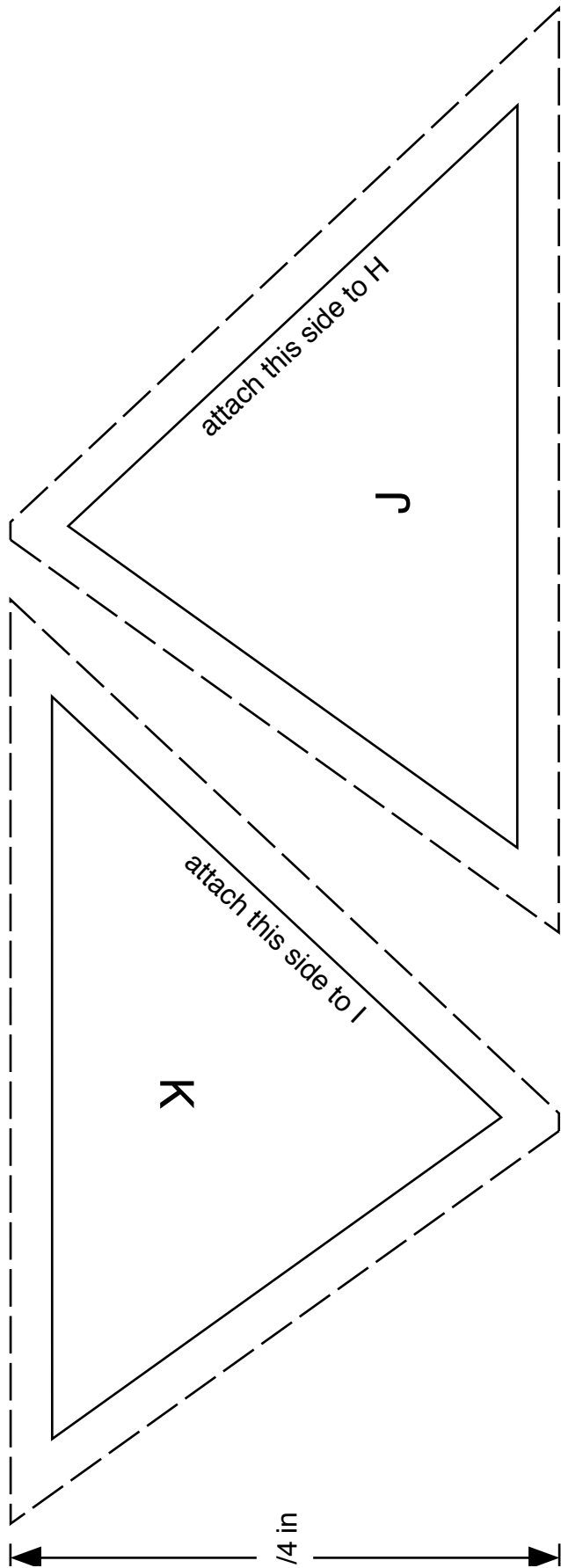

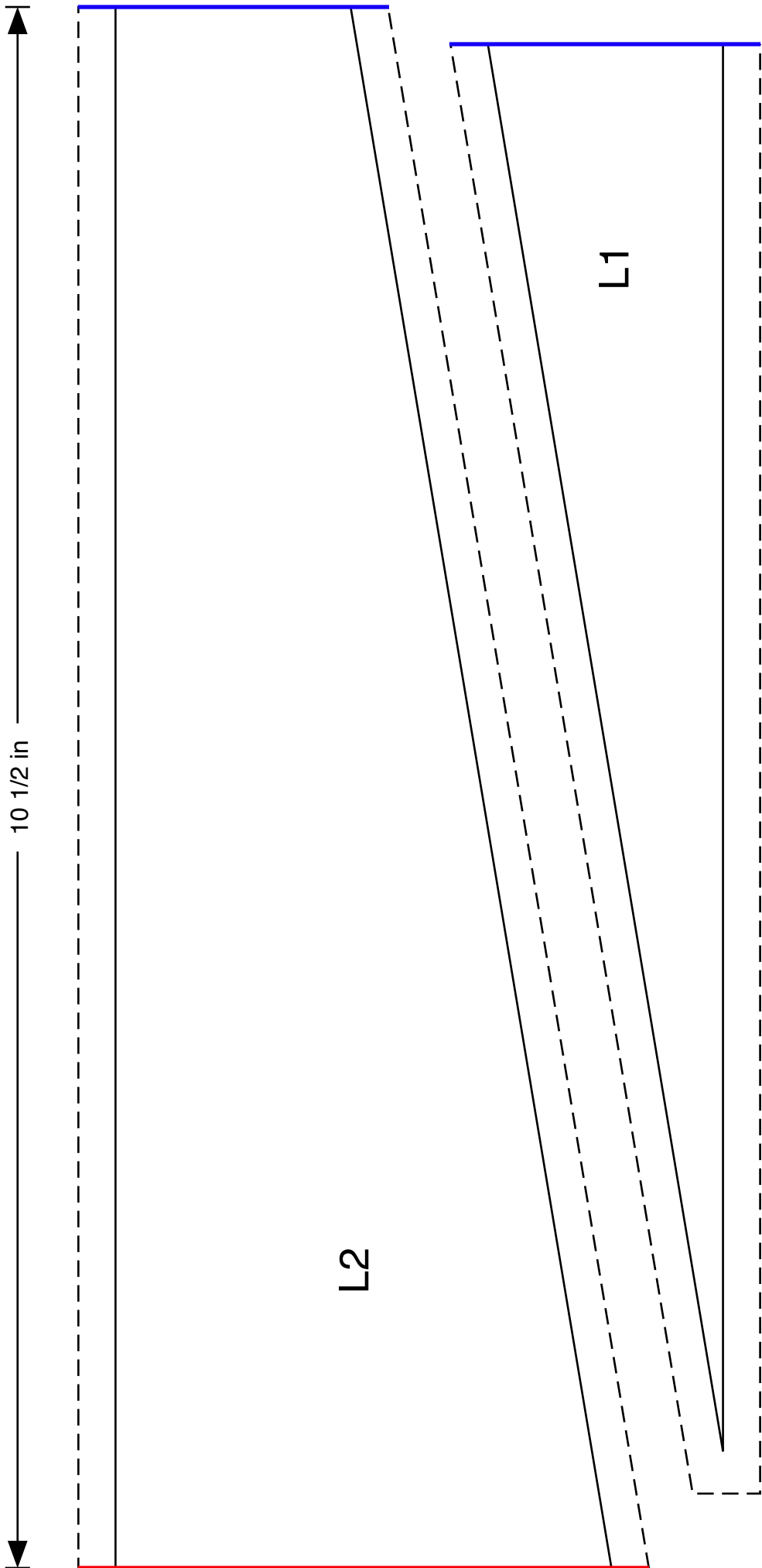

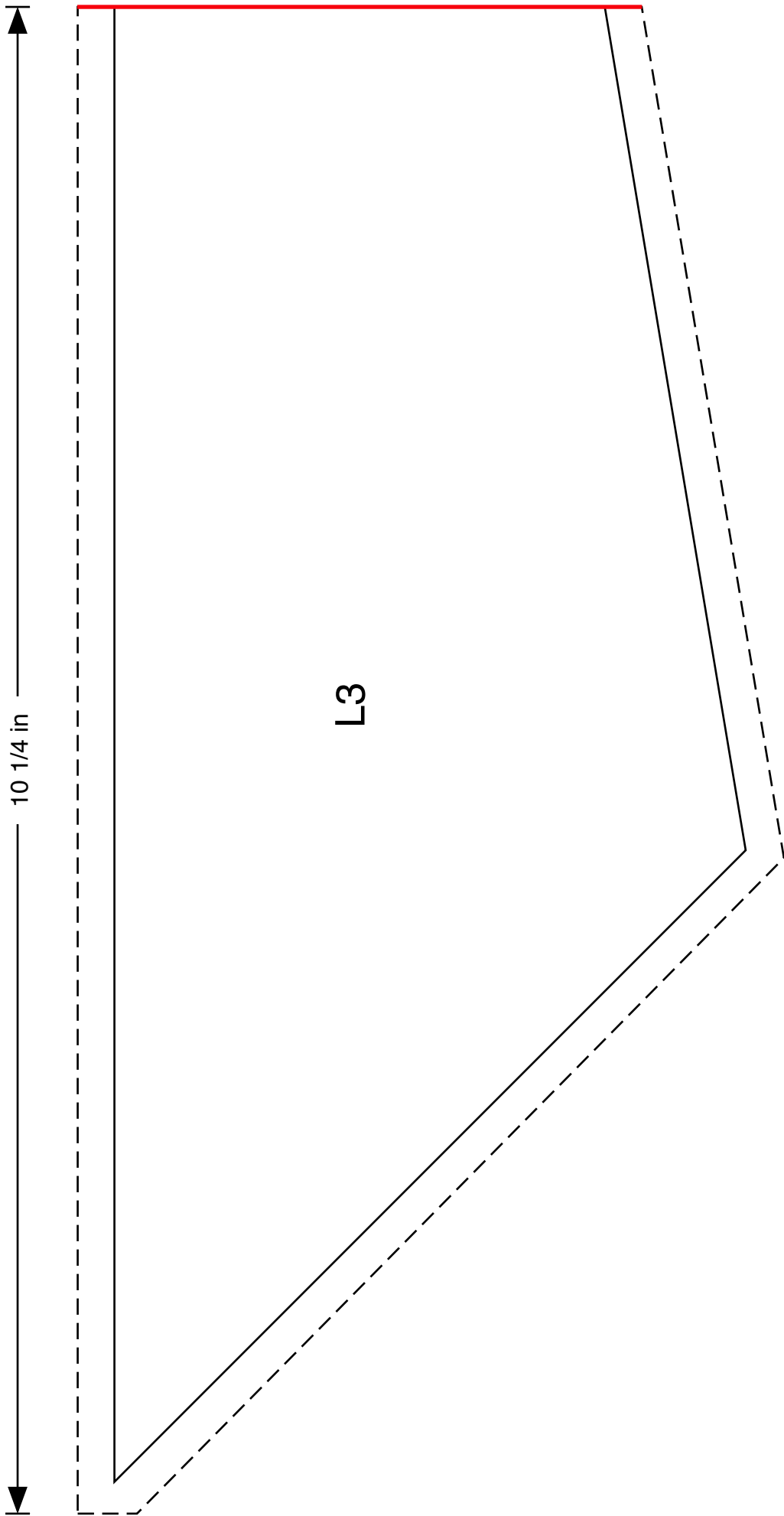

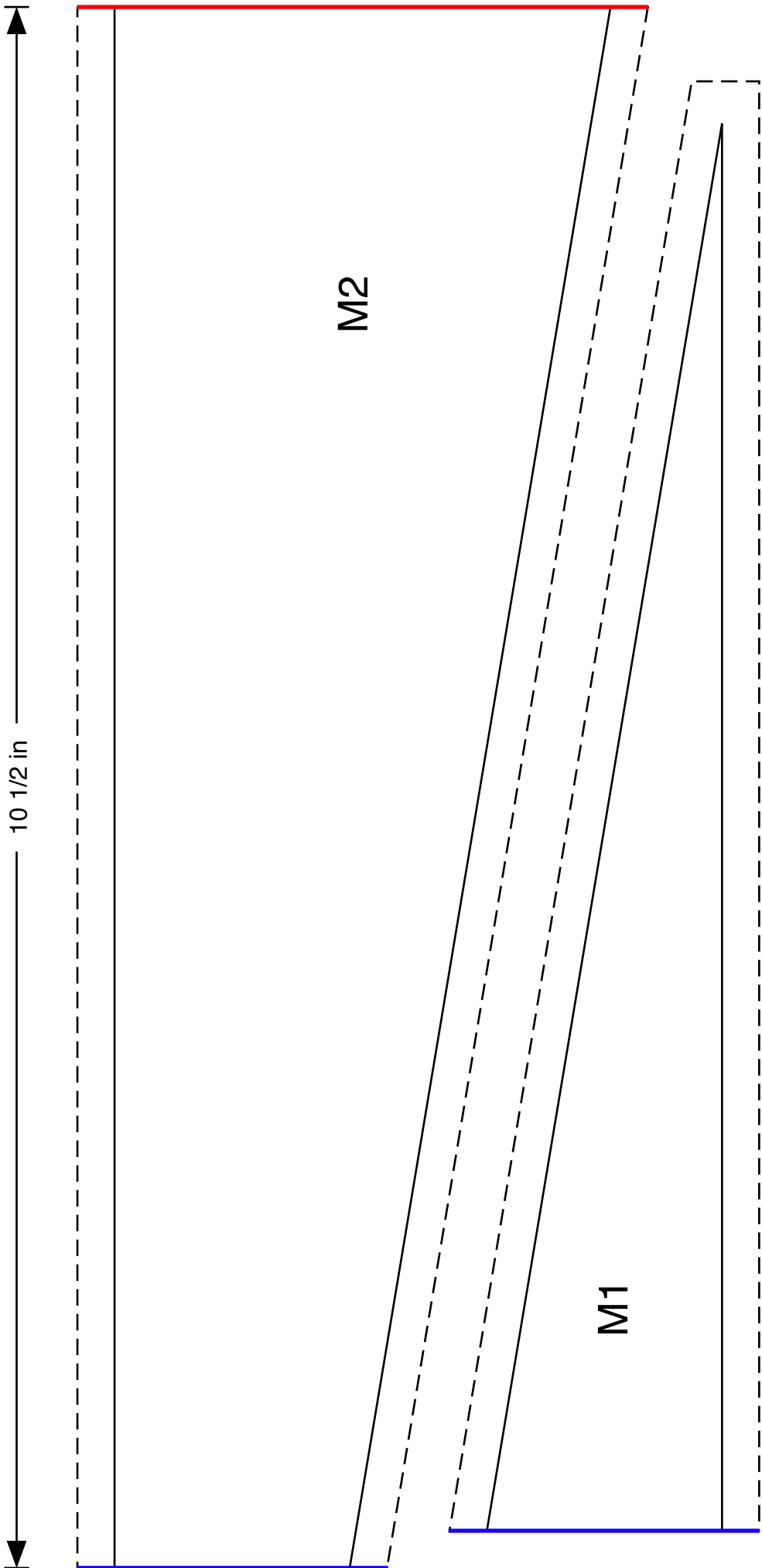

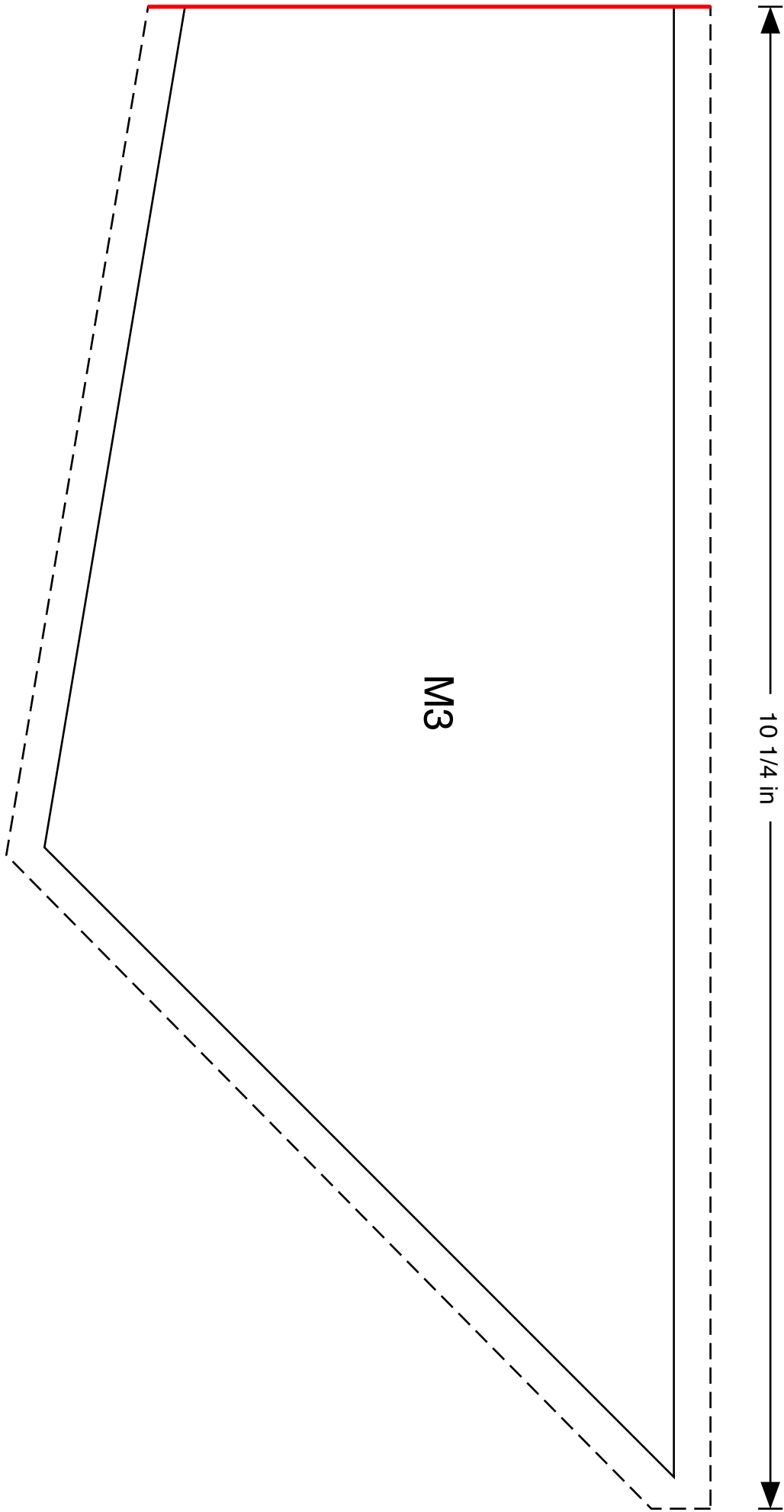

M3

10 1/4 in

N6

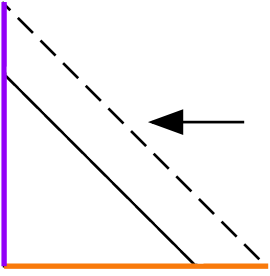

N5

N4

7 3/4 in

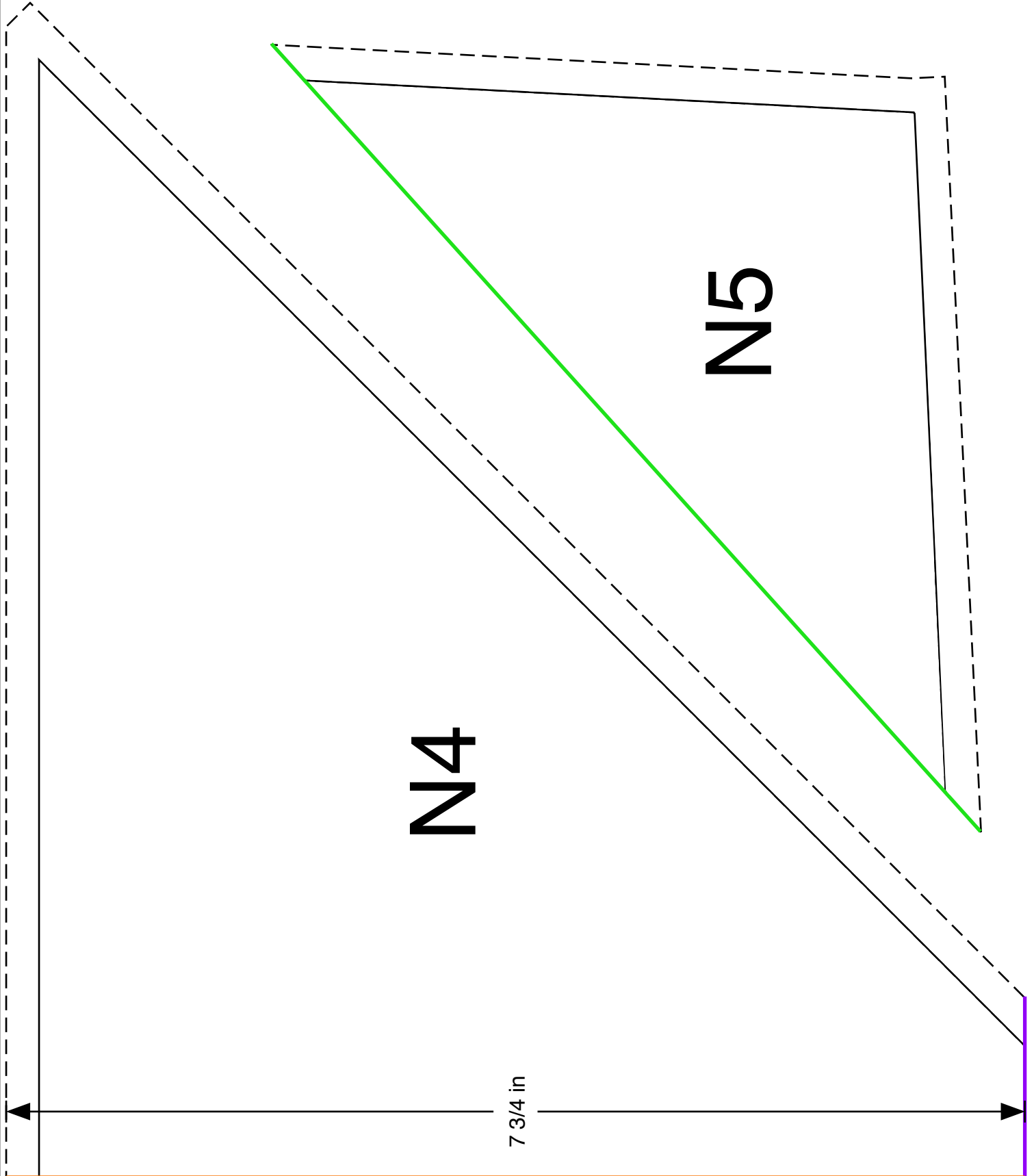

N1

10 3/4 in



N2

8 in

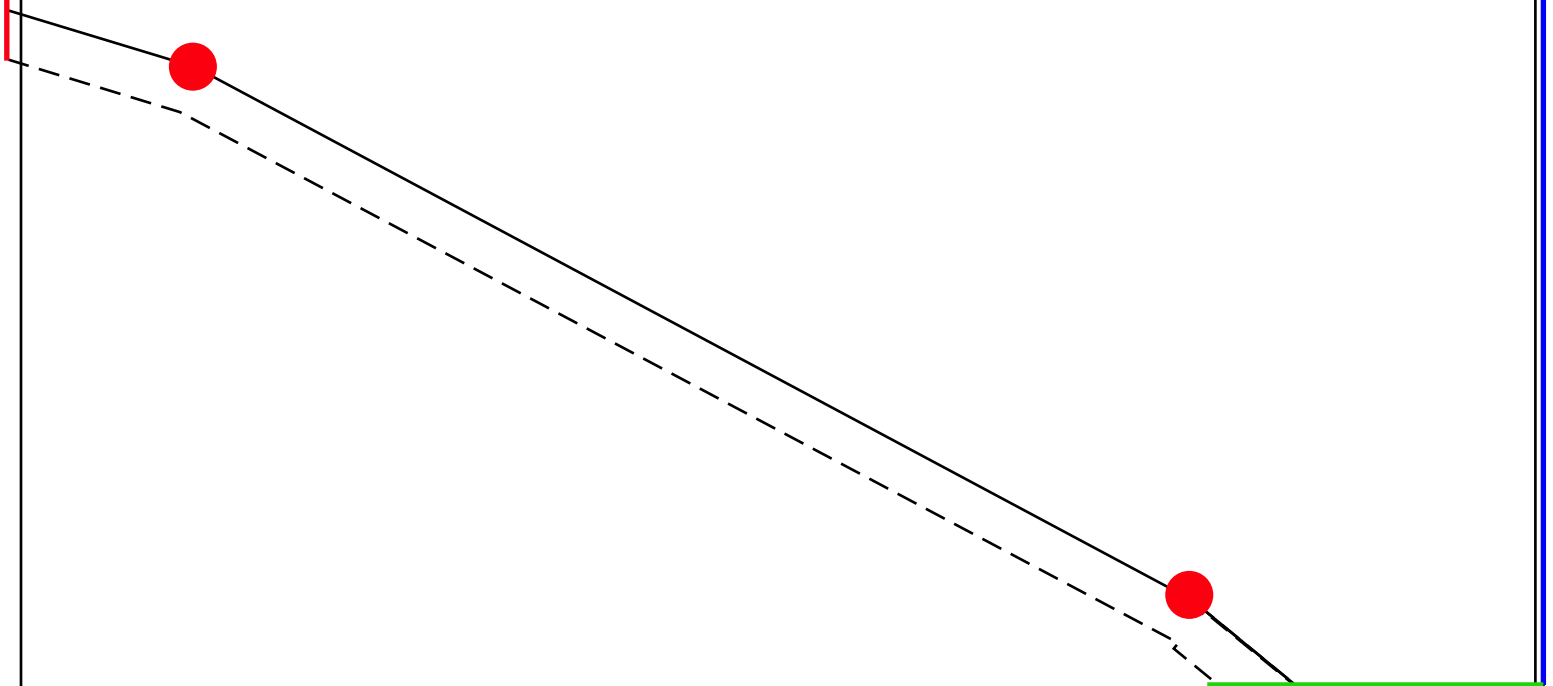

N3

8 in

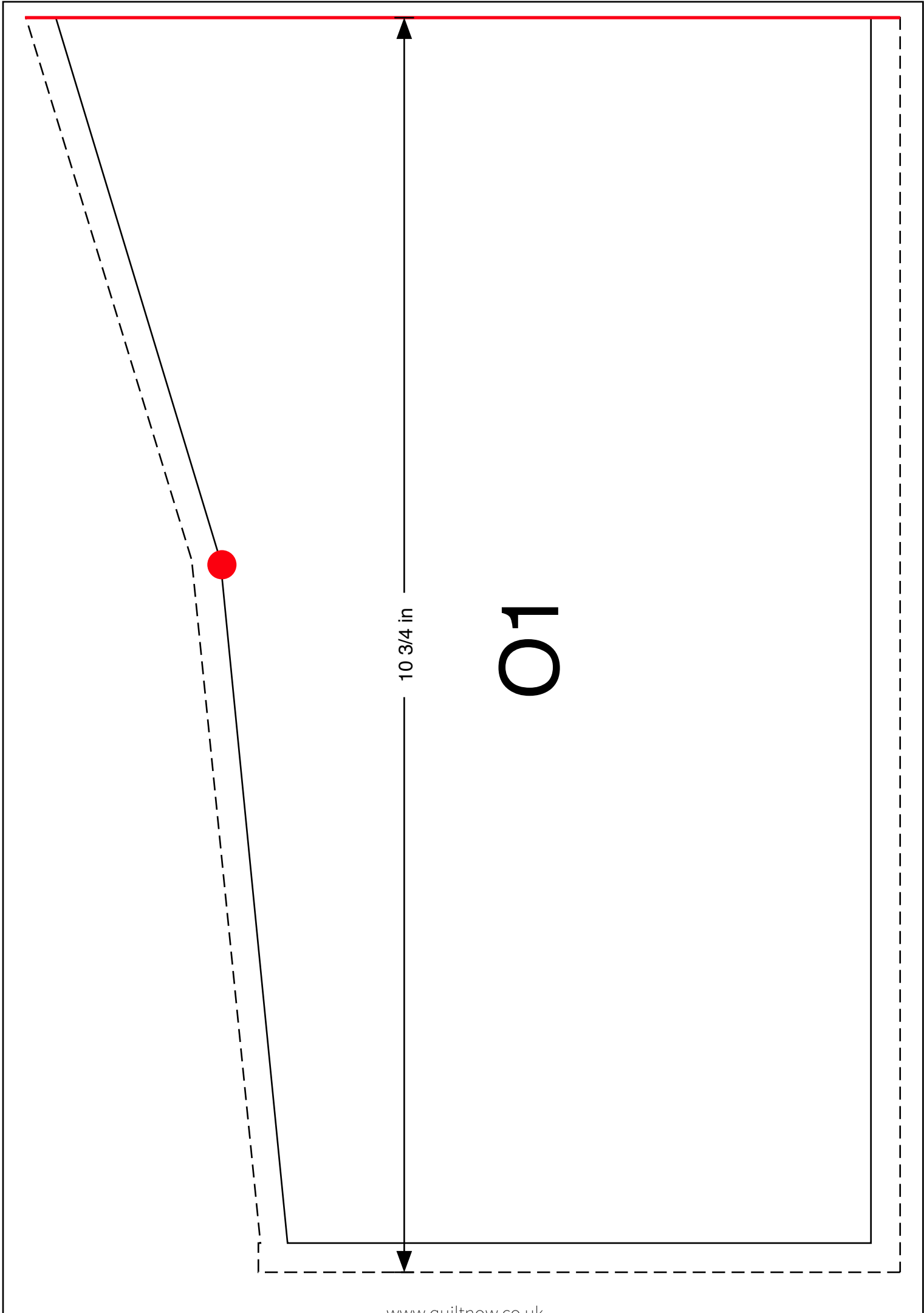

O1

$10 \frac{3}{4}$ in

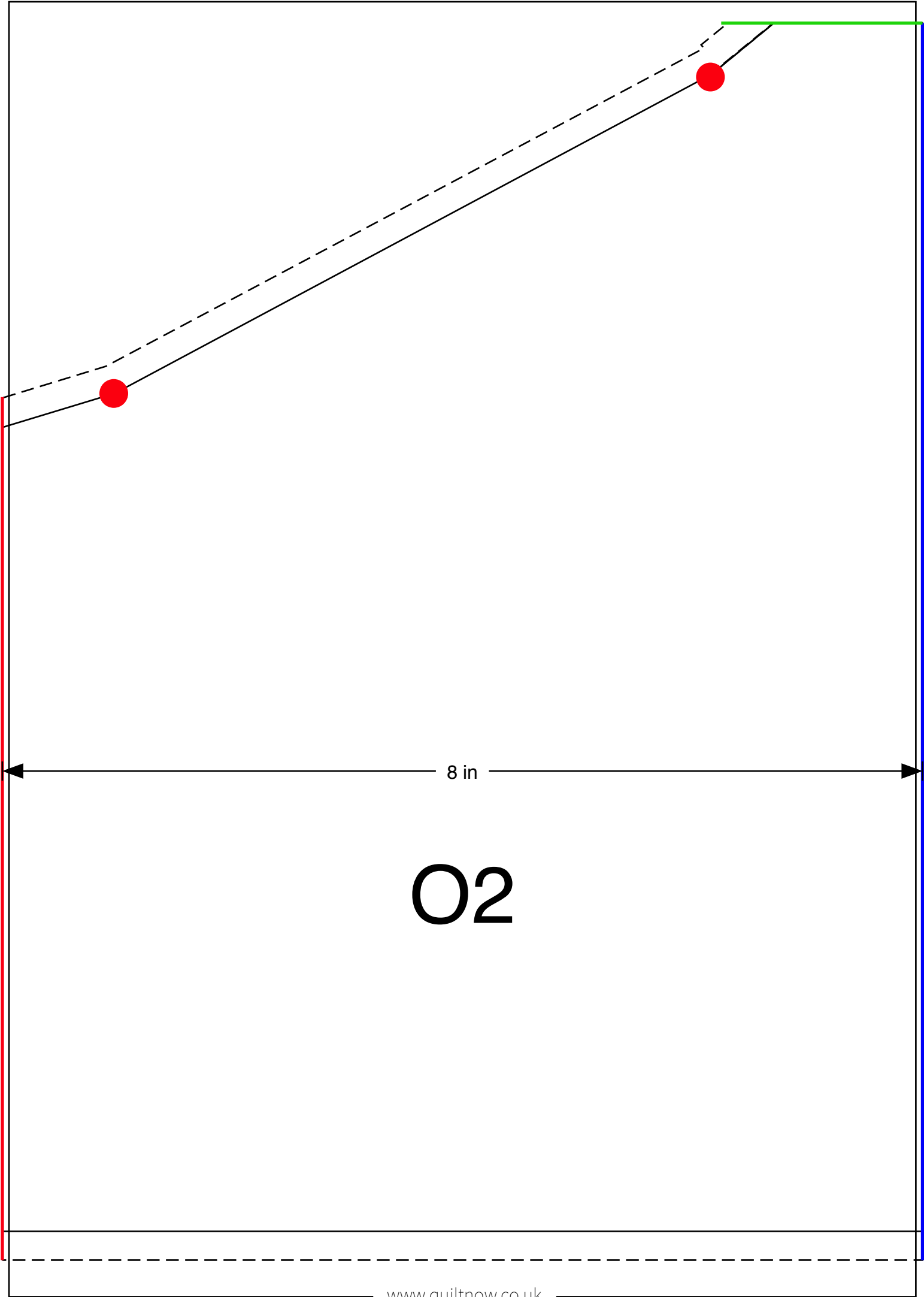

O2

8 in

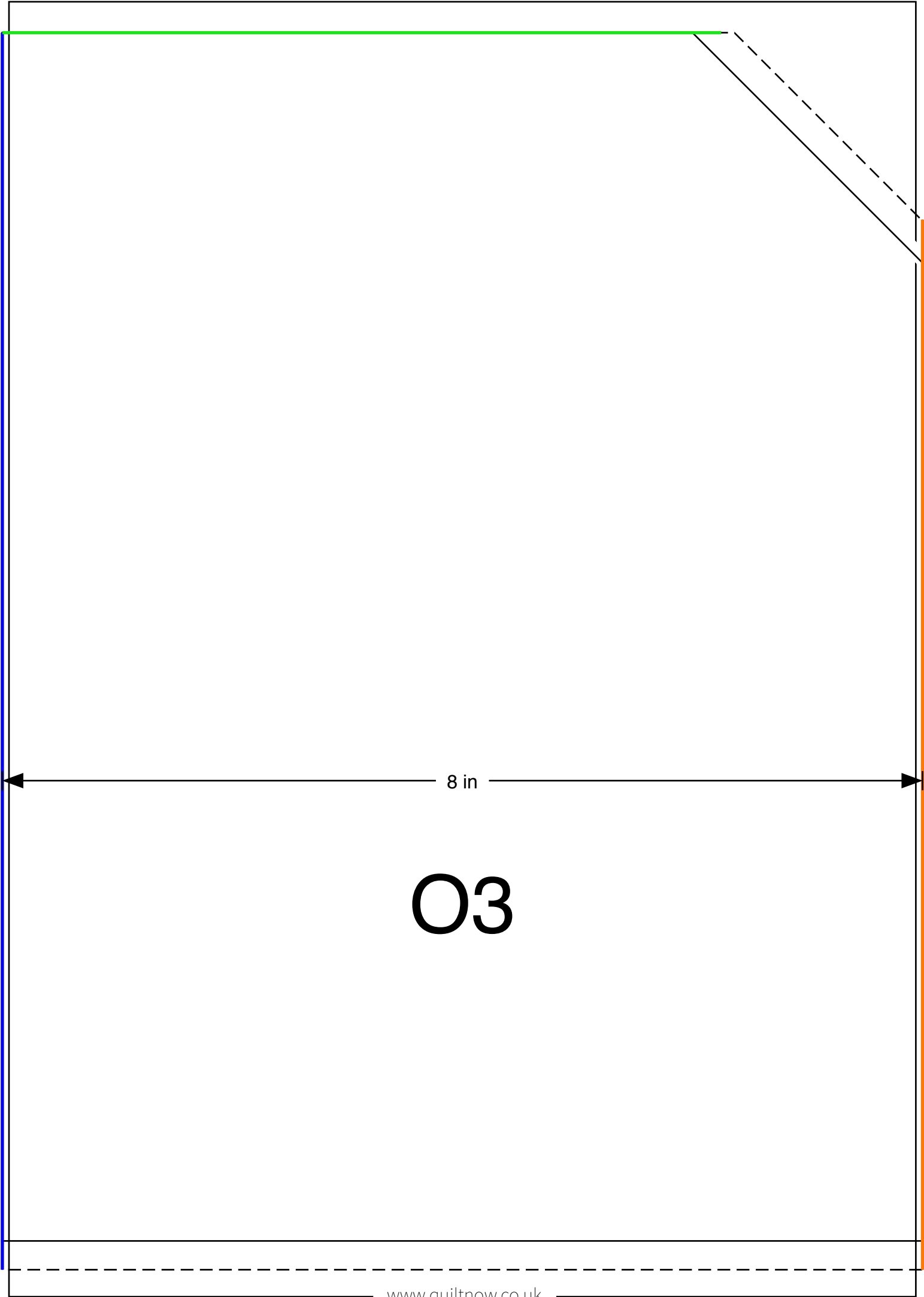

8 in

O3

O5

O4

O6

7 3/4 in

