

# Onesie Version B

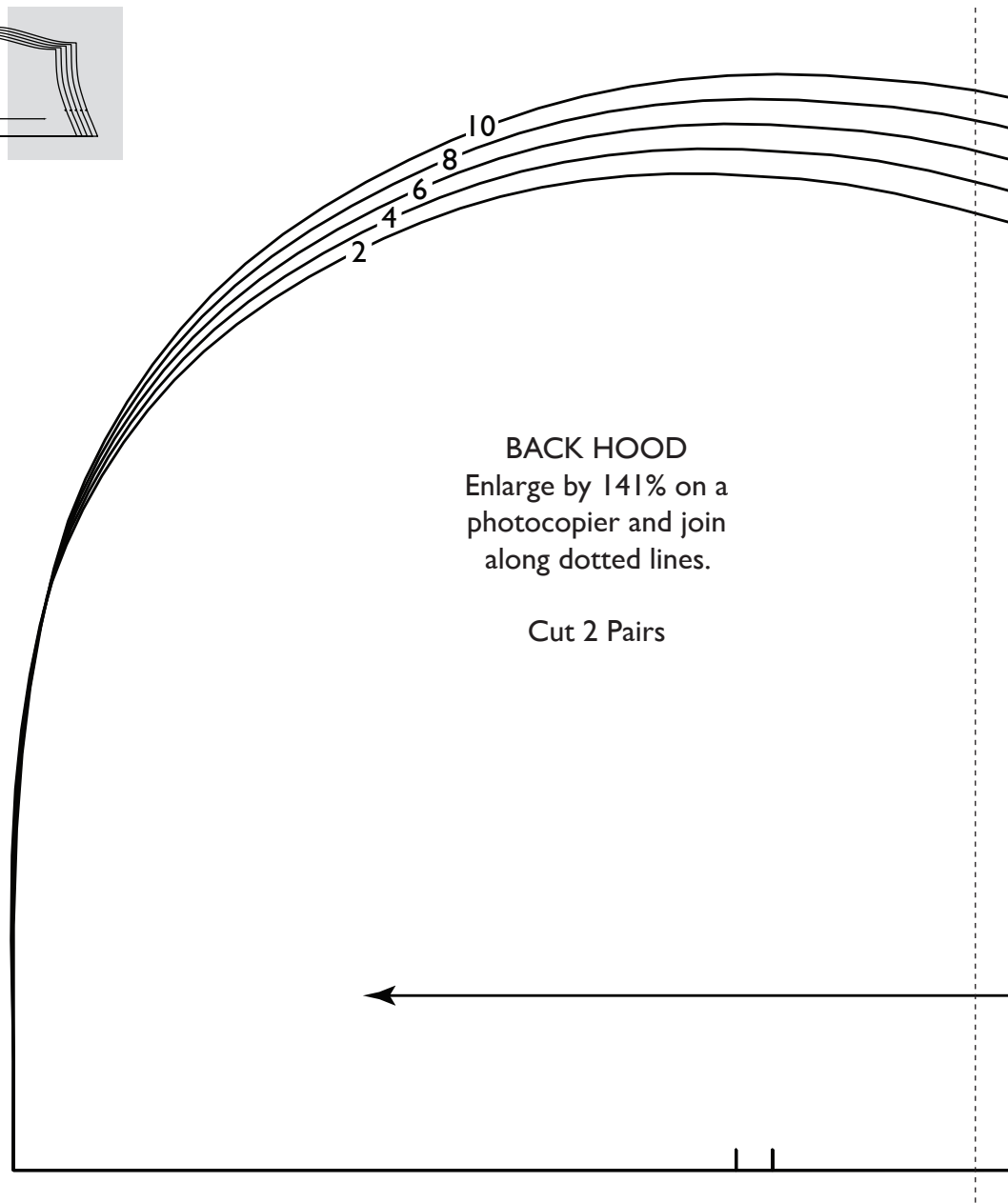

# Onesie Version B

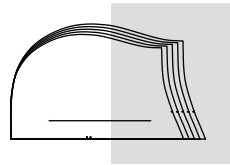
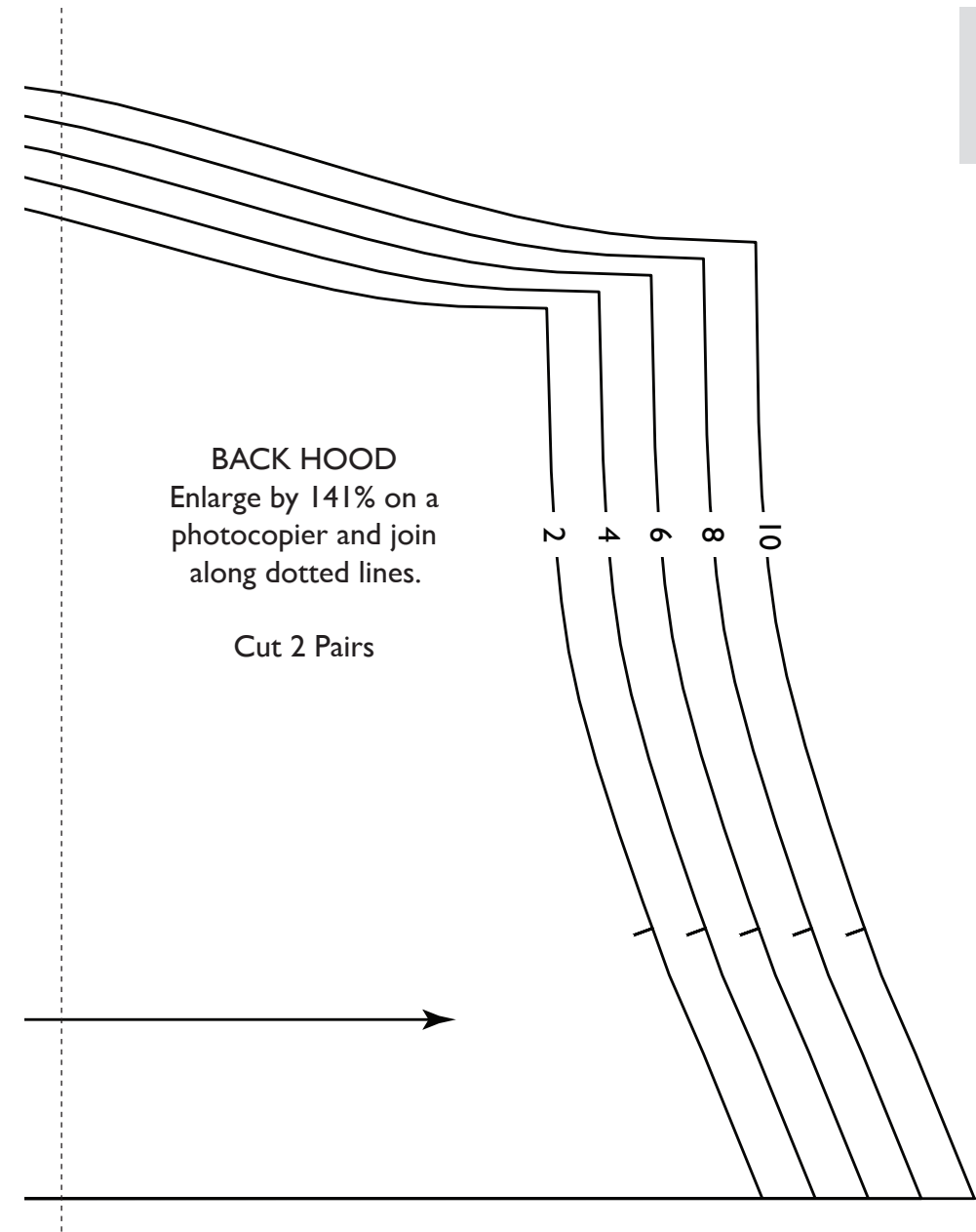
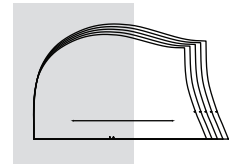

# Onesie Version B

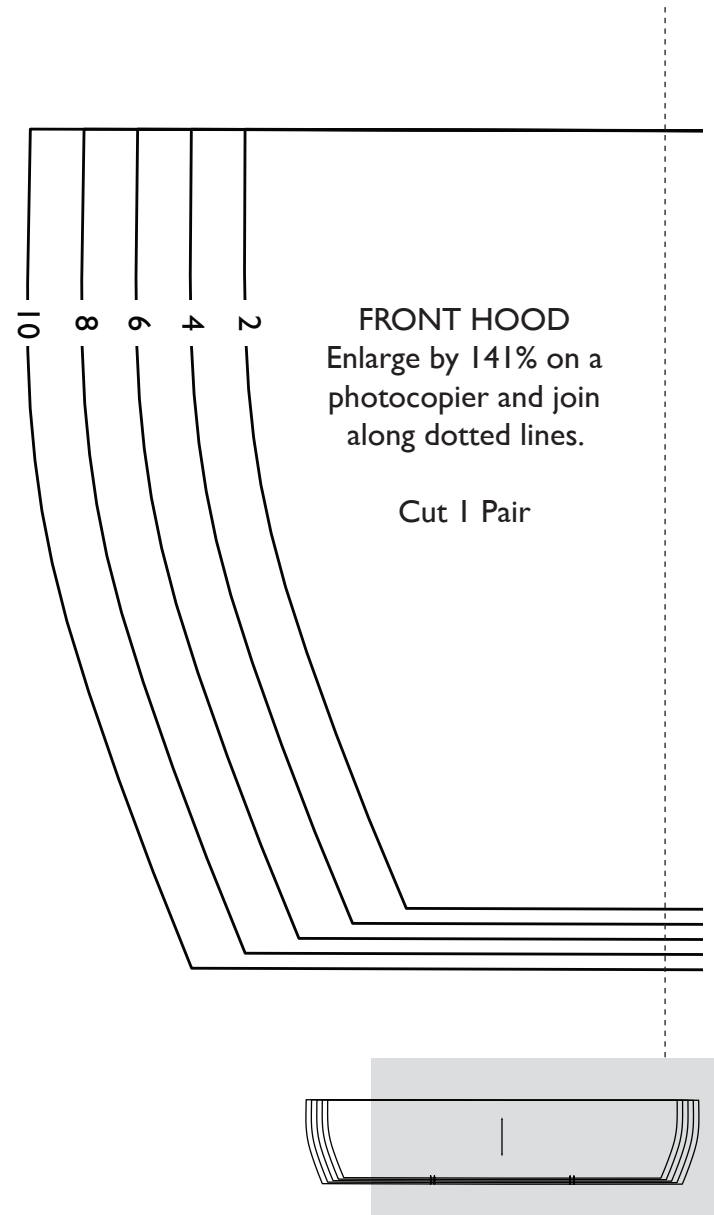

# Onesie Version B

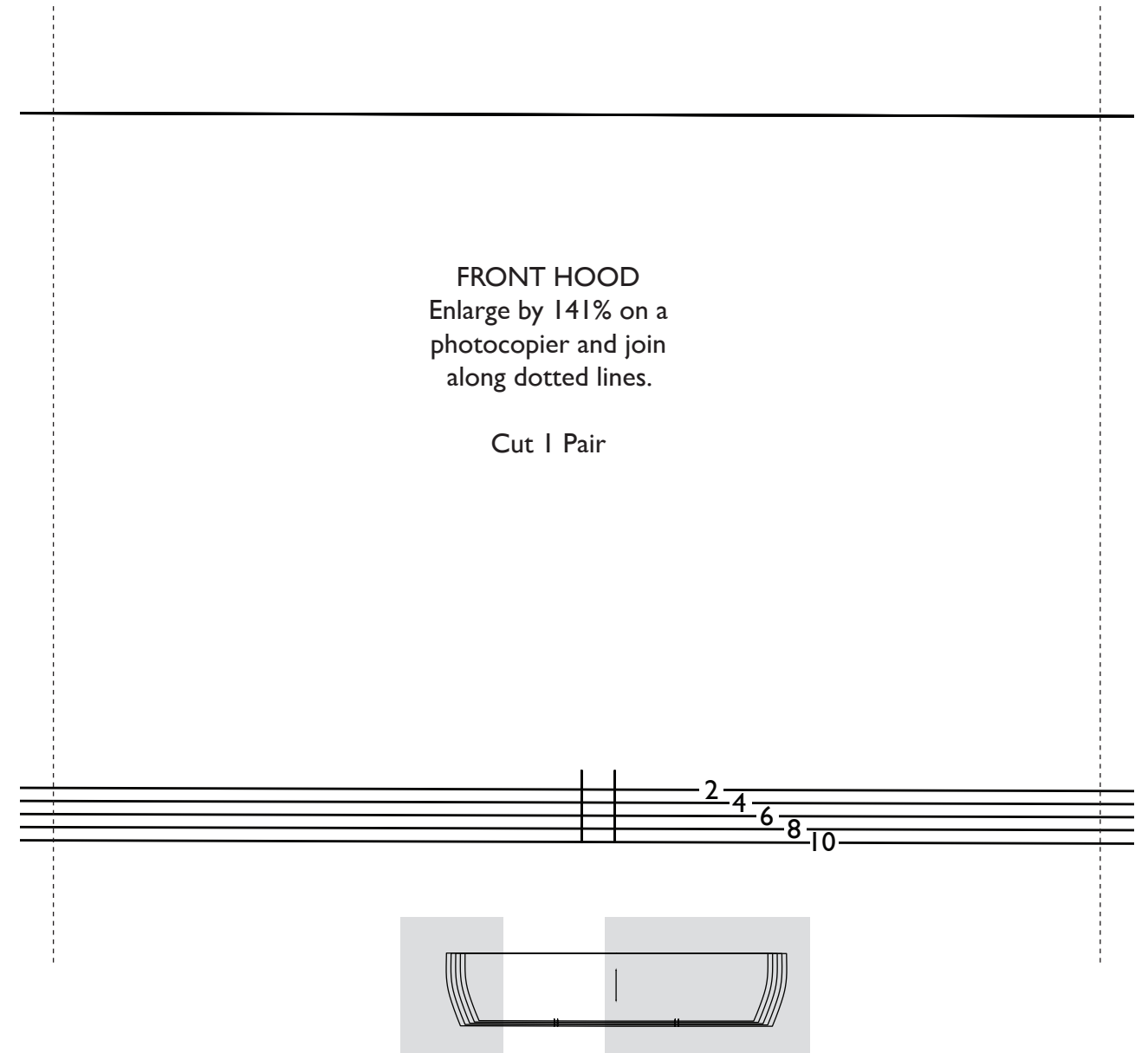

# Onesie Version B

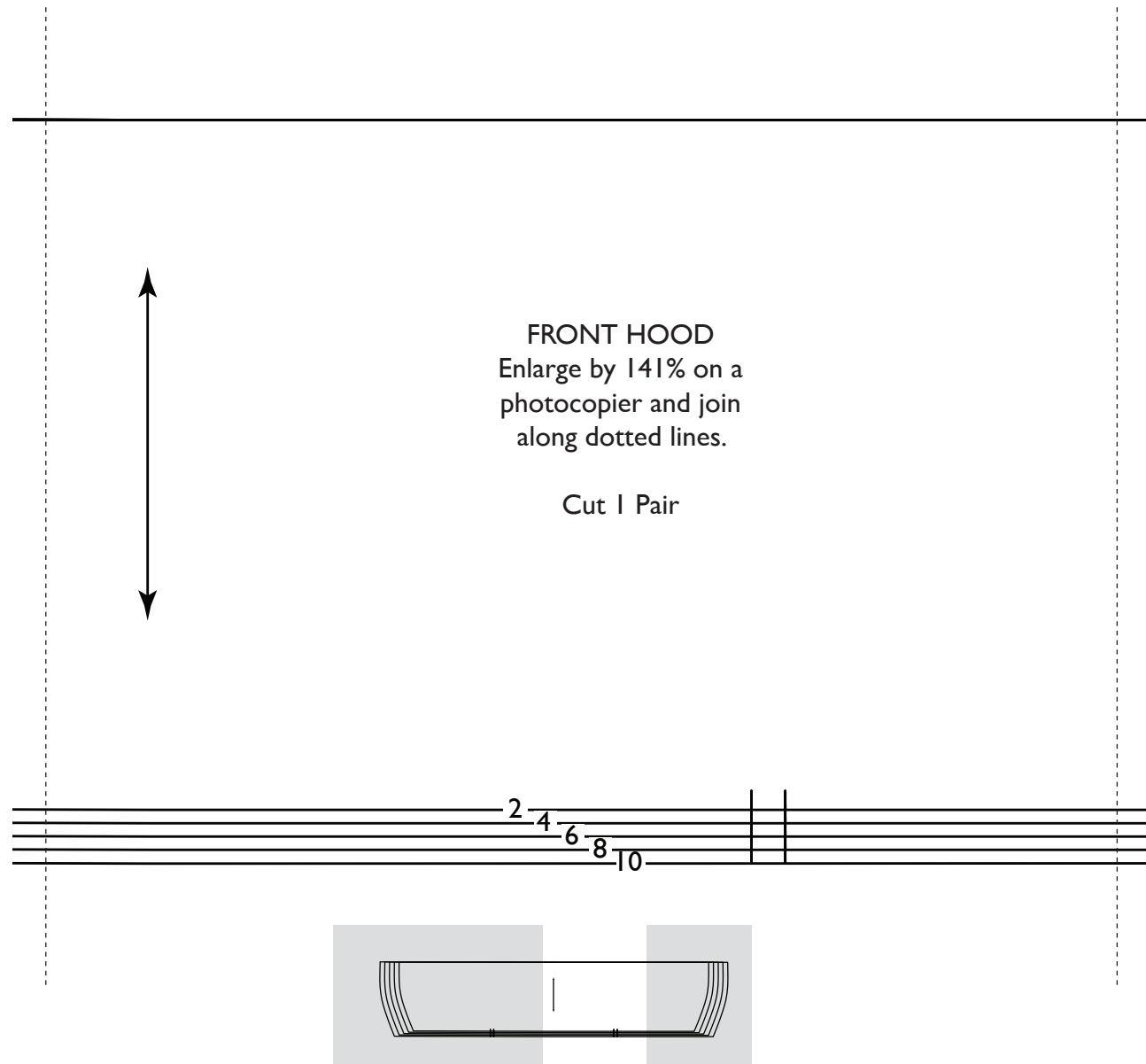

# Onesie Version B

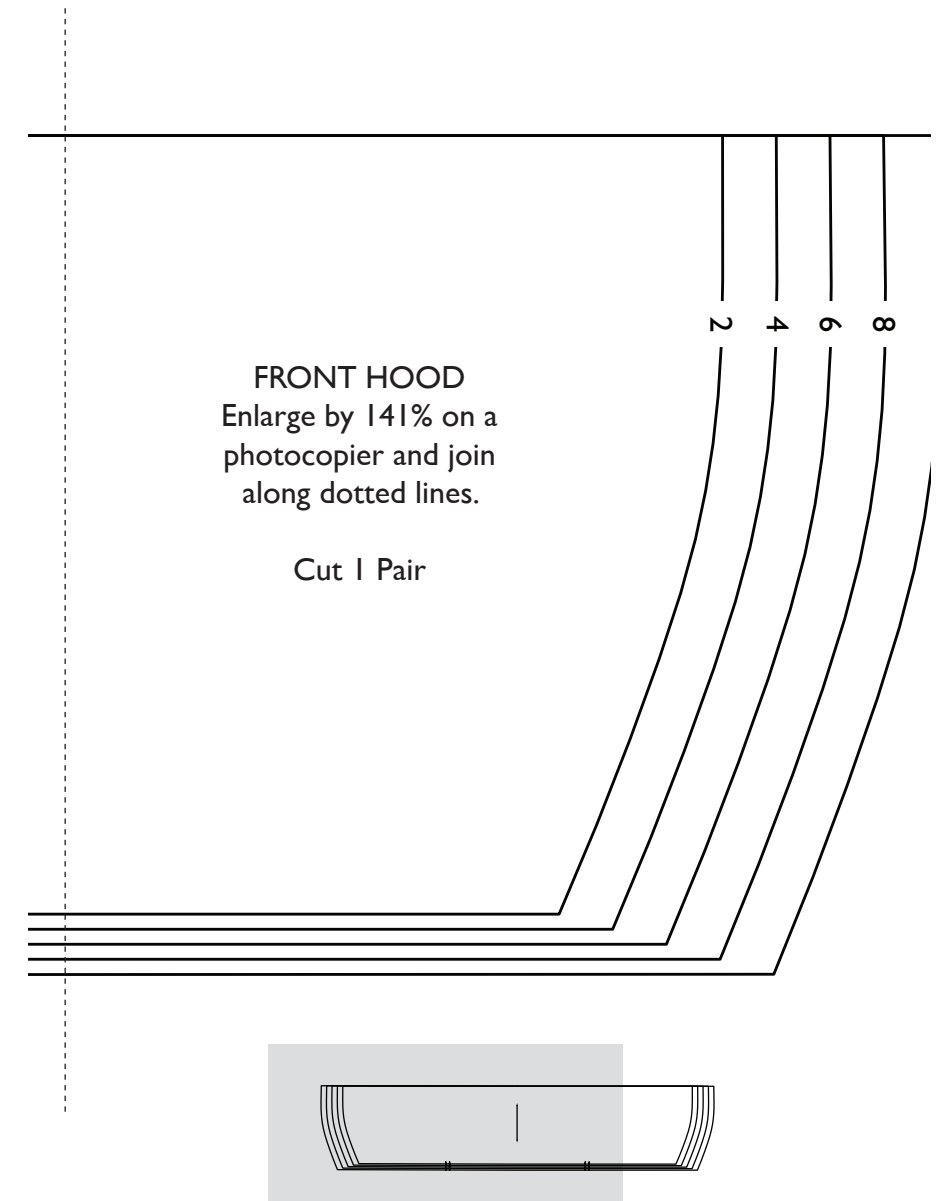

# Onesie Version B

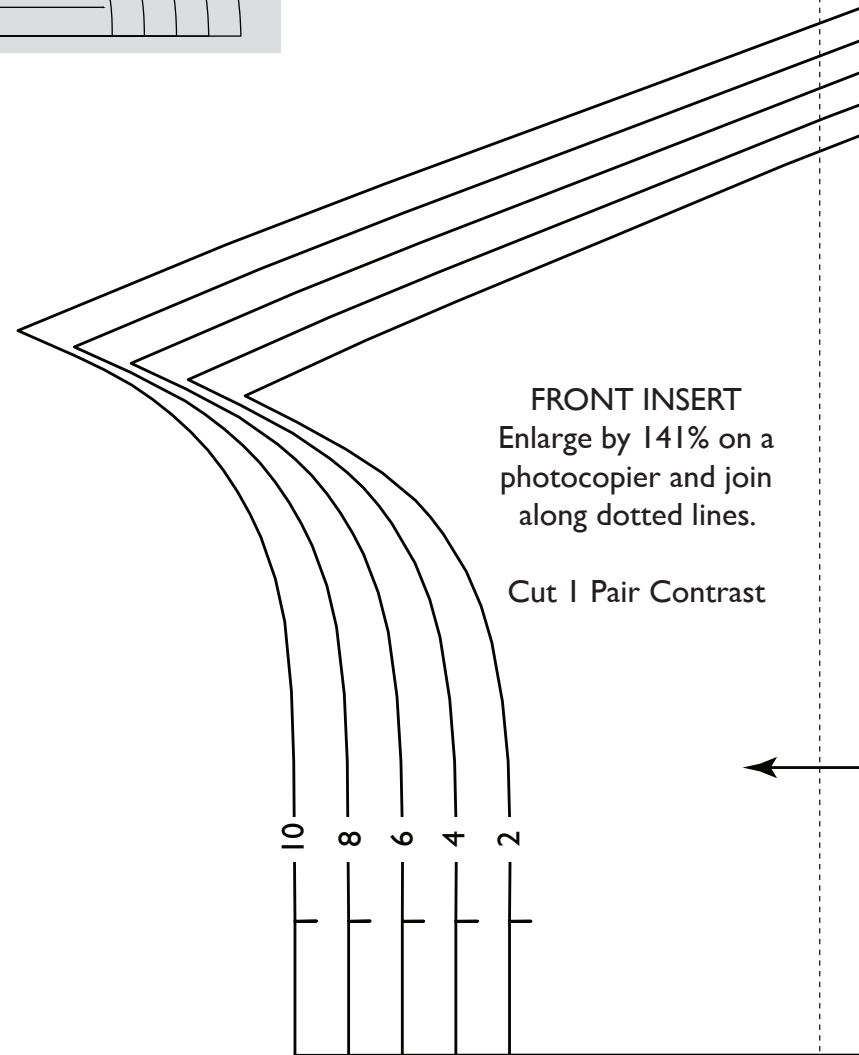
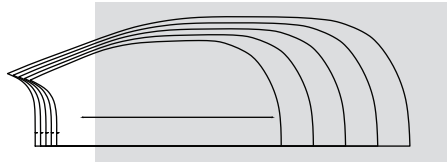

# Onesie Version B

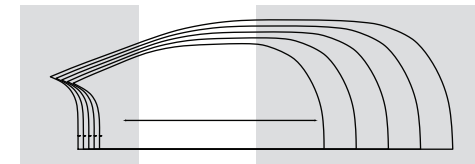
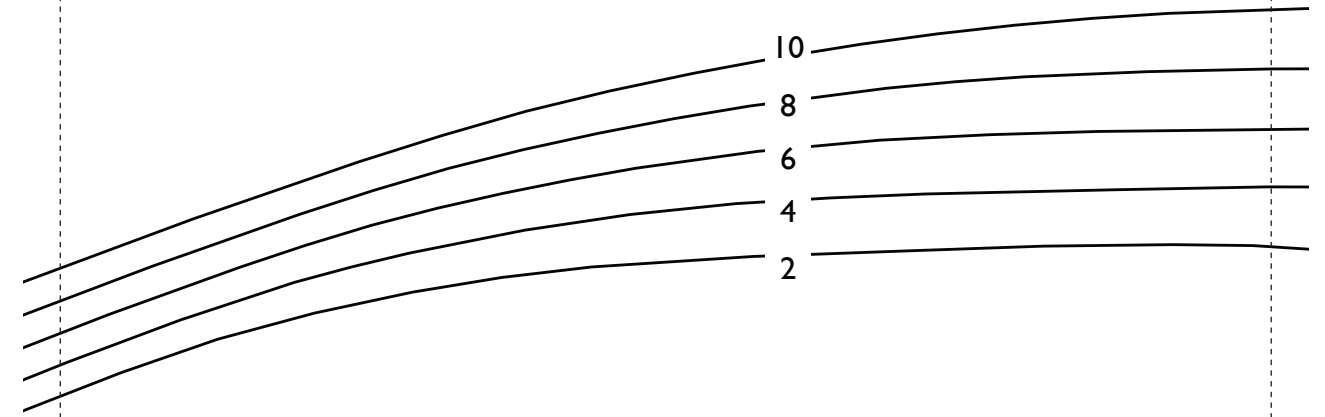

FRONT INSERT  
Enlarge by 141% on a  
photocopier and join  
along dotted lines.

Cut | Pair Contrast

# Onesie Version B

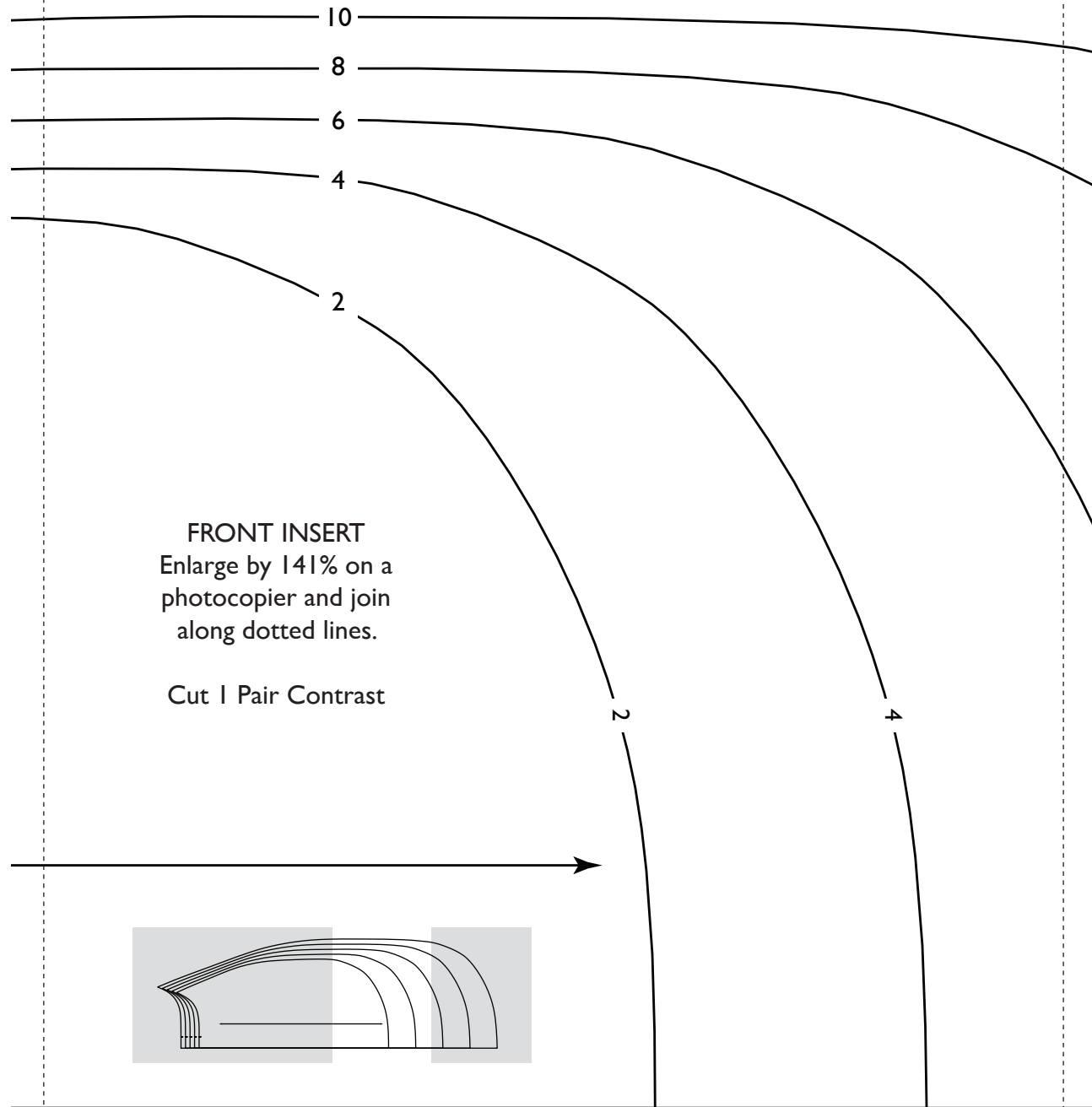

# Onesie Version B

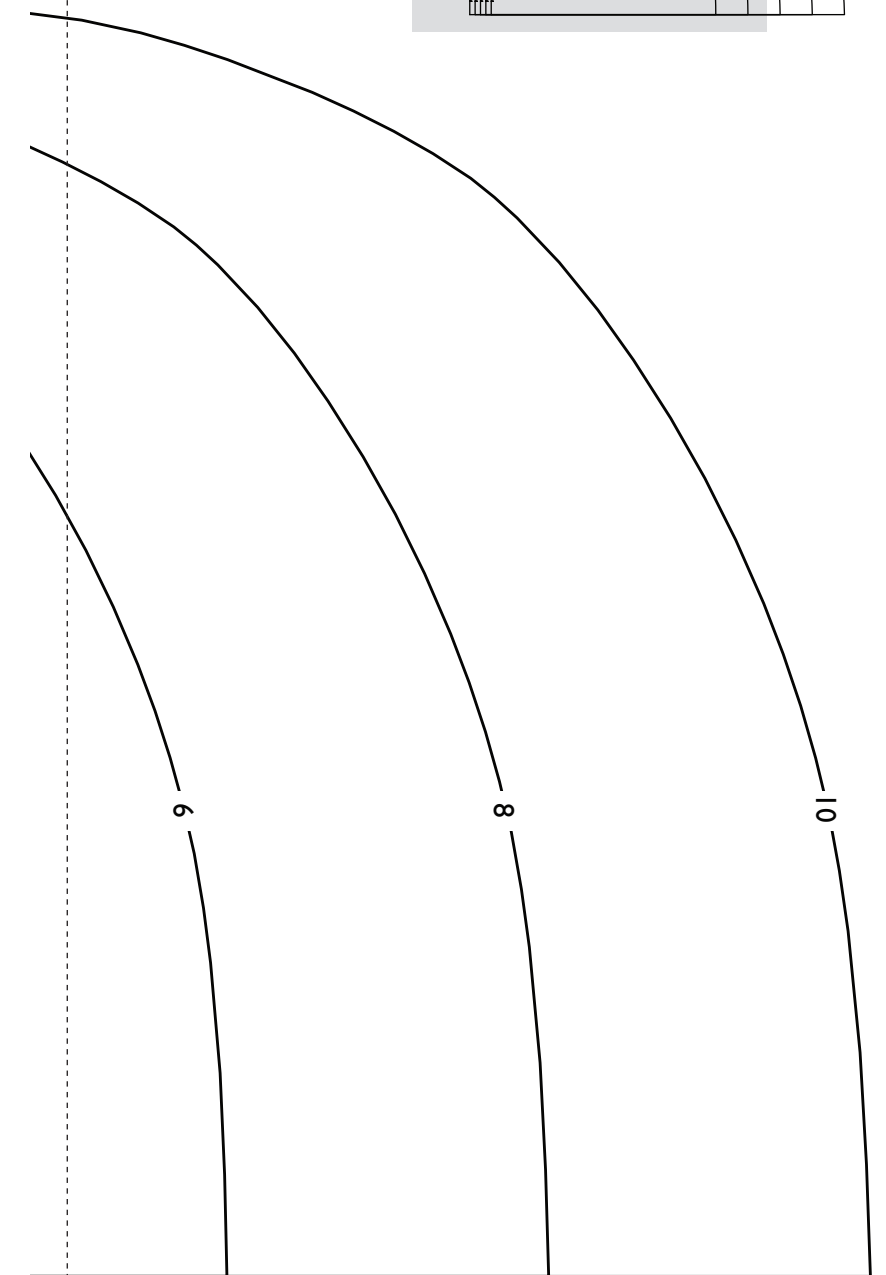
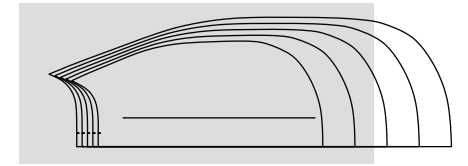

# Onesie Version B

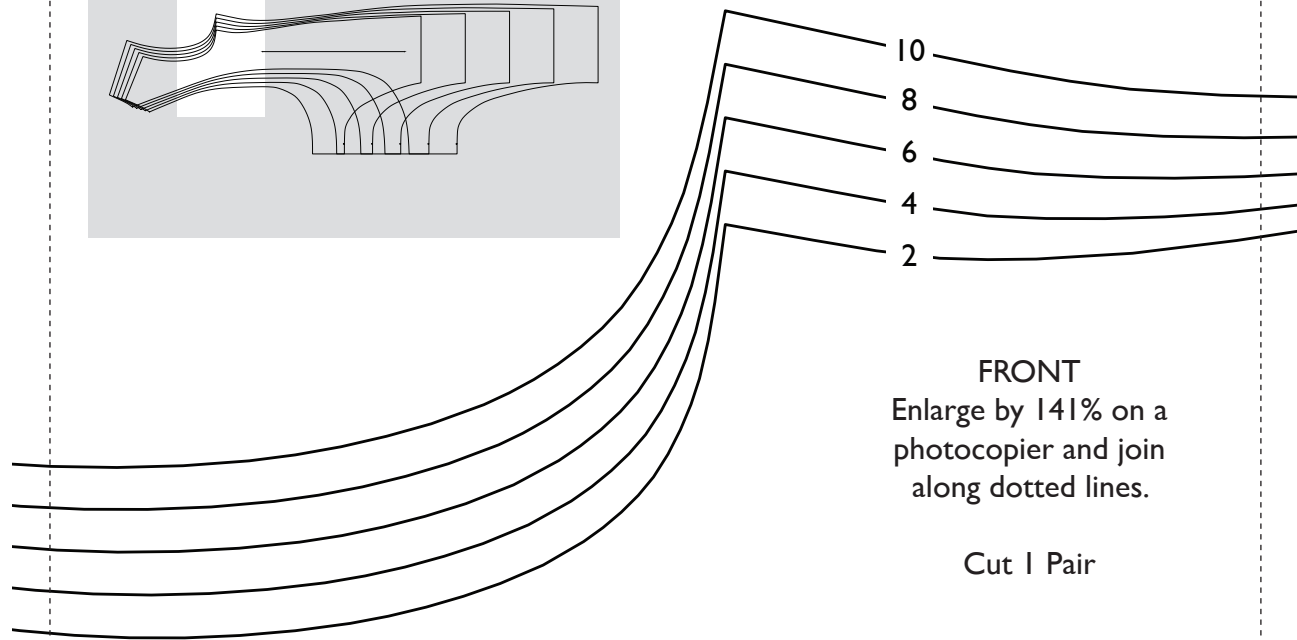
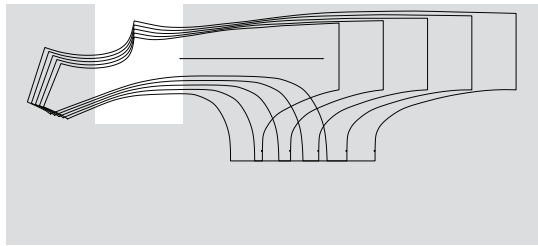

FRONT  
Enlarge by 141% on a  
photocopier and join  
along dotted lines.

Cut 1 Pair

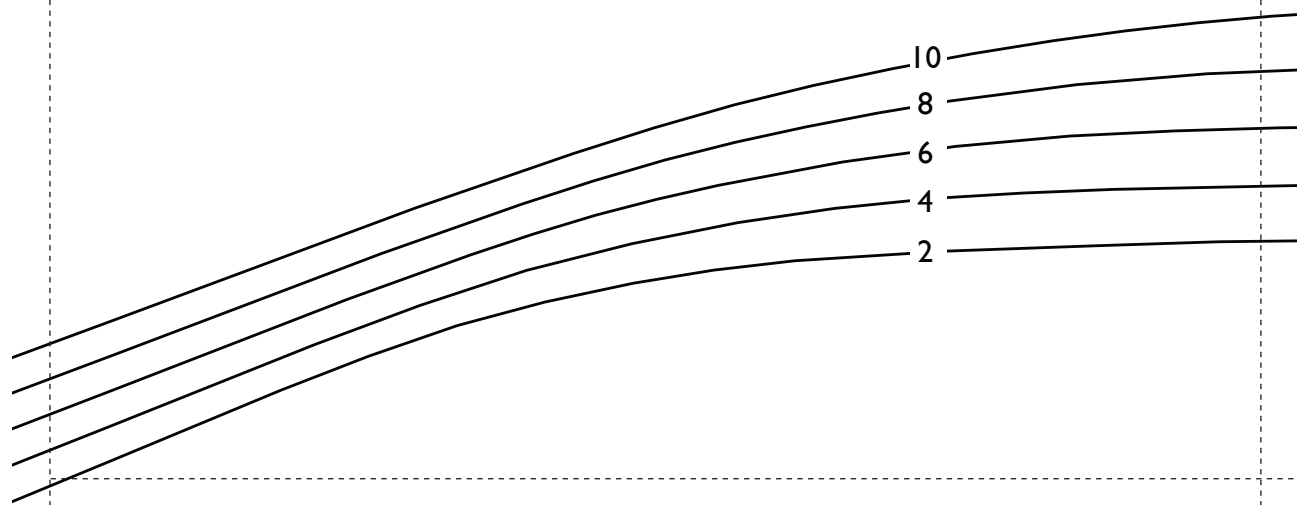

# Onesie Version B

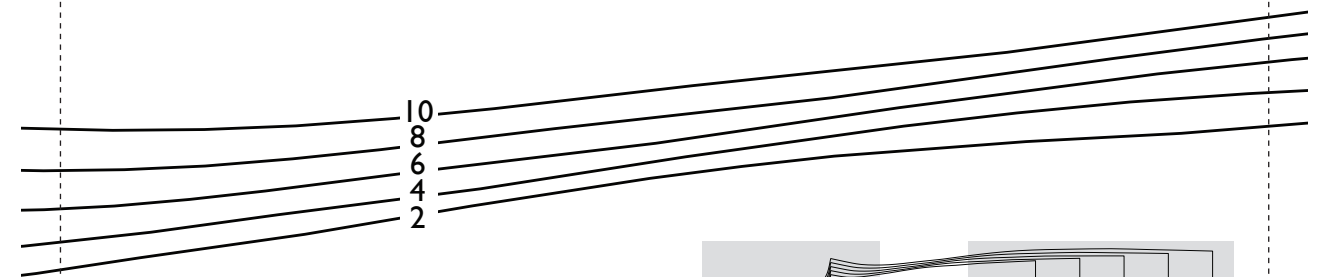
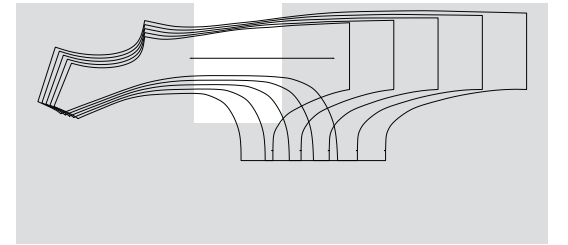

FRONT  
Enlarge by 141% on a  
photocopier and join  
along dotted lines.

Cut 1 Pair

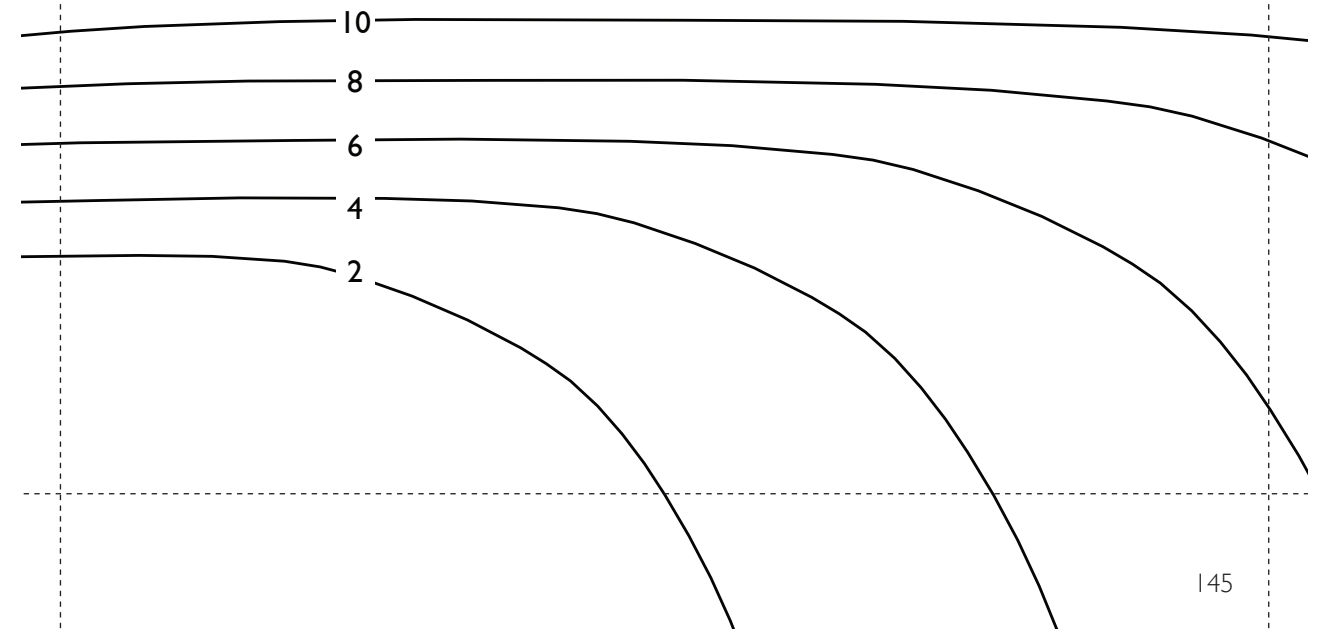
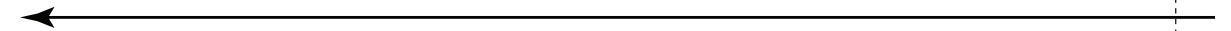

# Onesie Version B

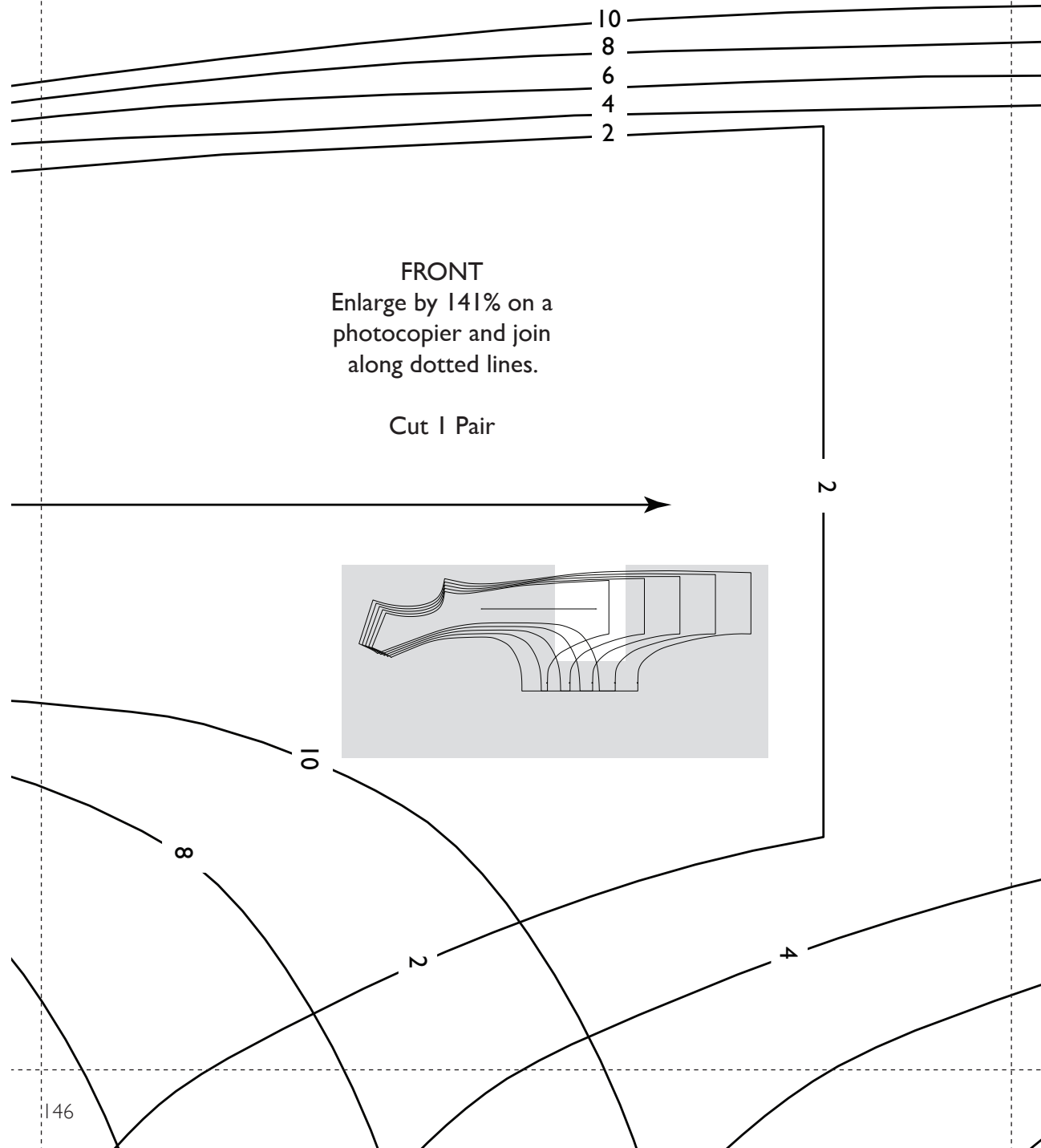

# Onesie Version B

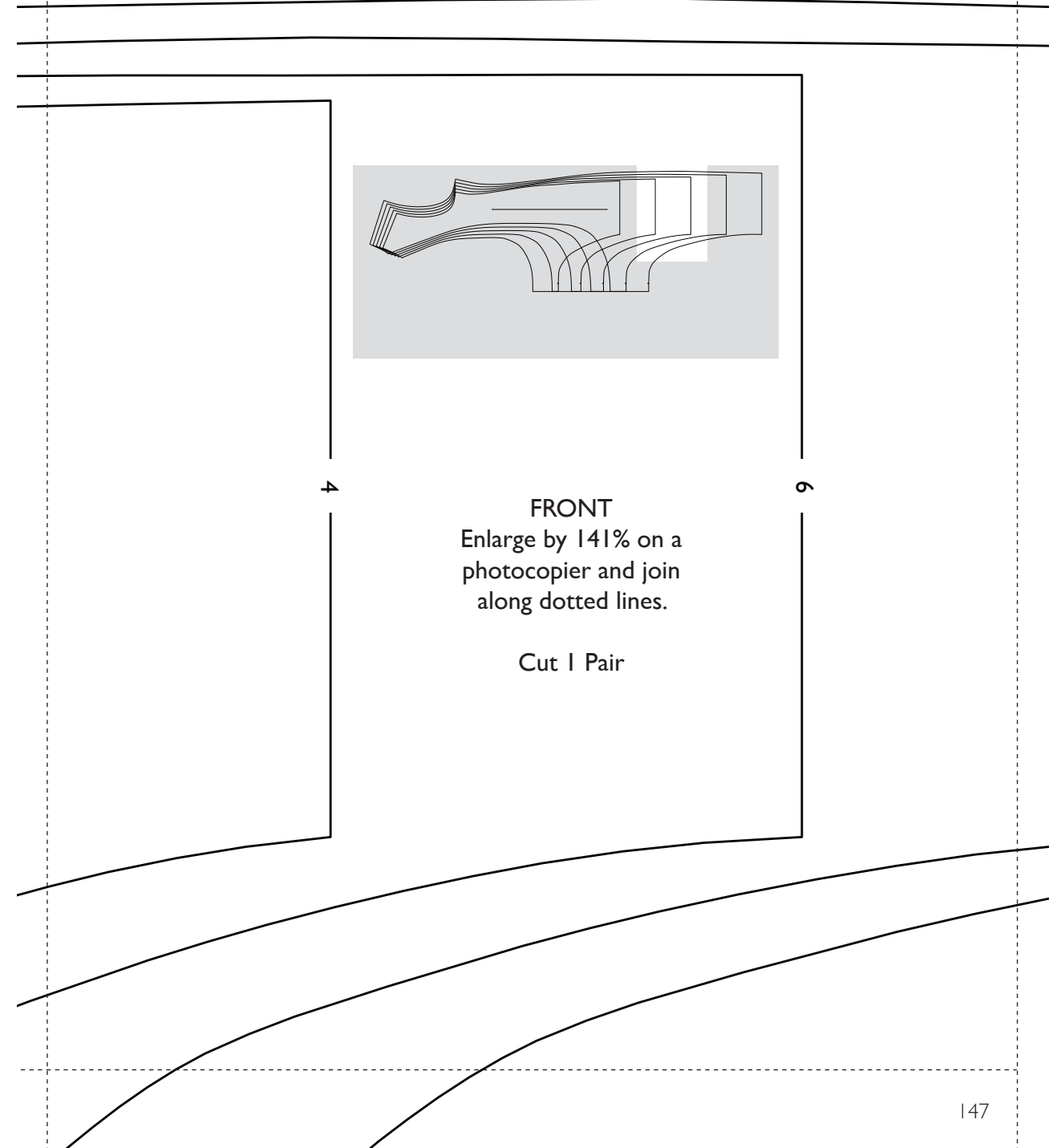

# Onesie Version B

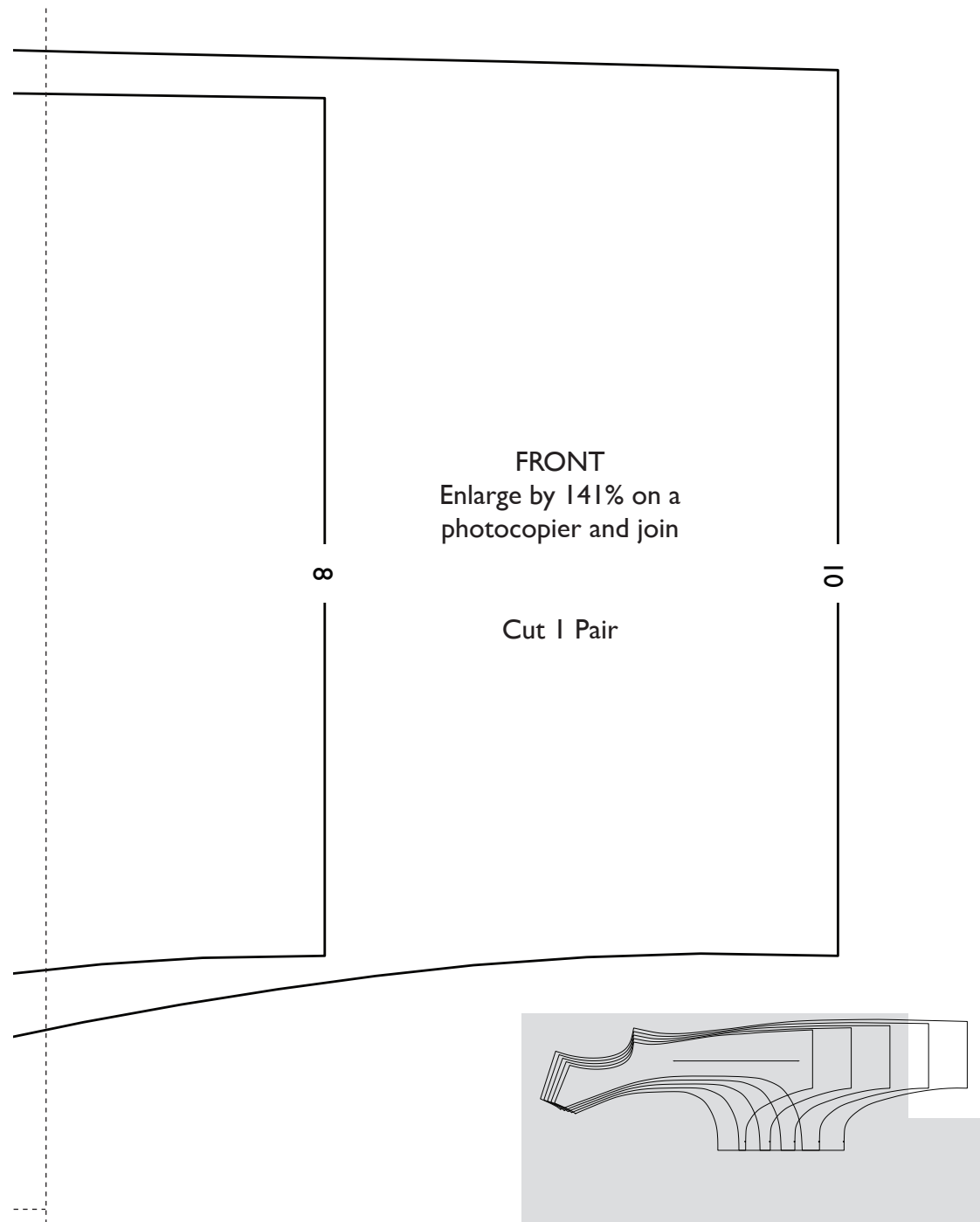

# Onesie Version B

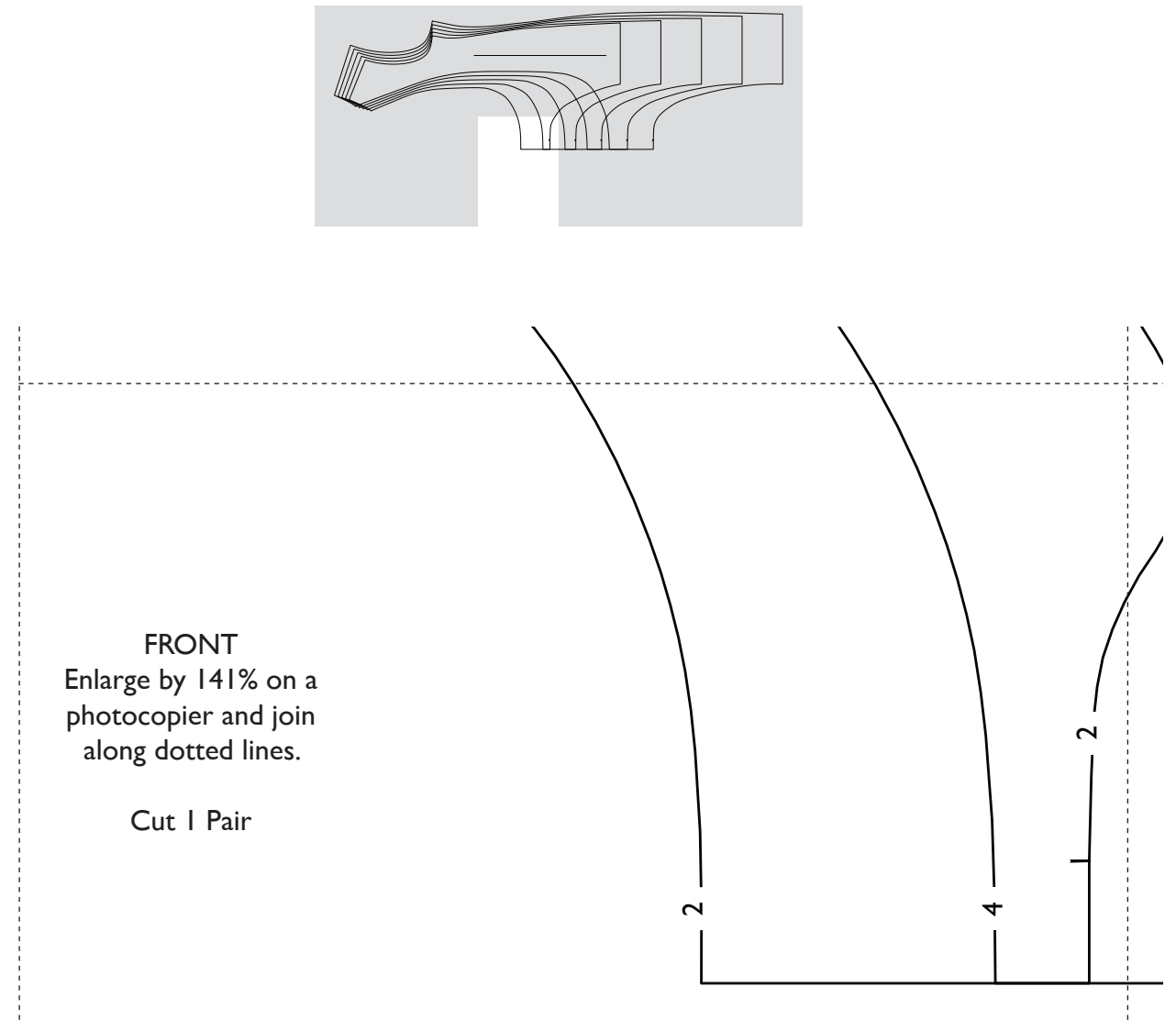



# Onesie Version B

FRONT  
Enlarge by 141% on a  
photocopier and join  
along dotted lines.

Cut 1 Pair

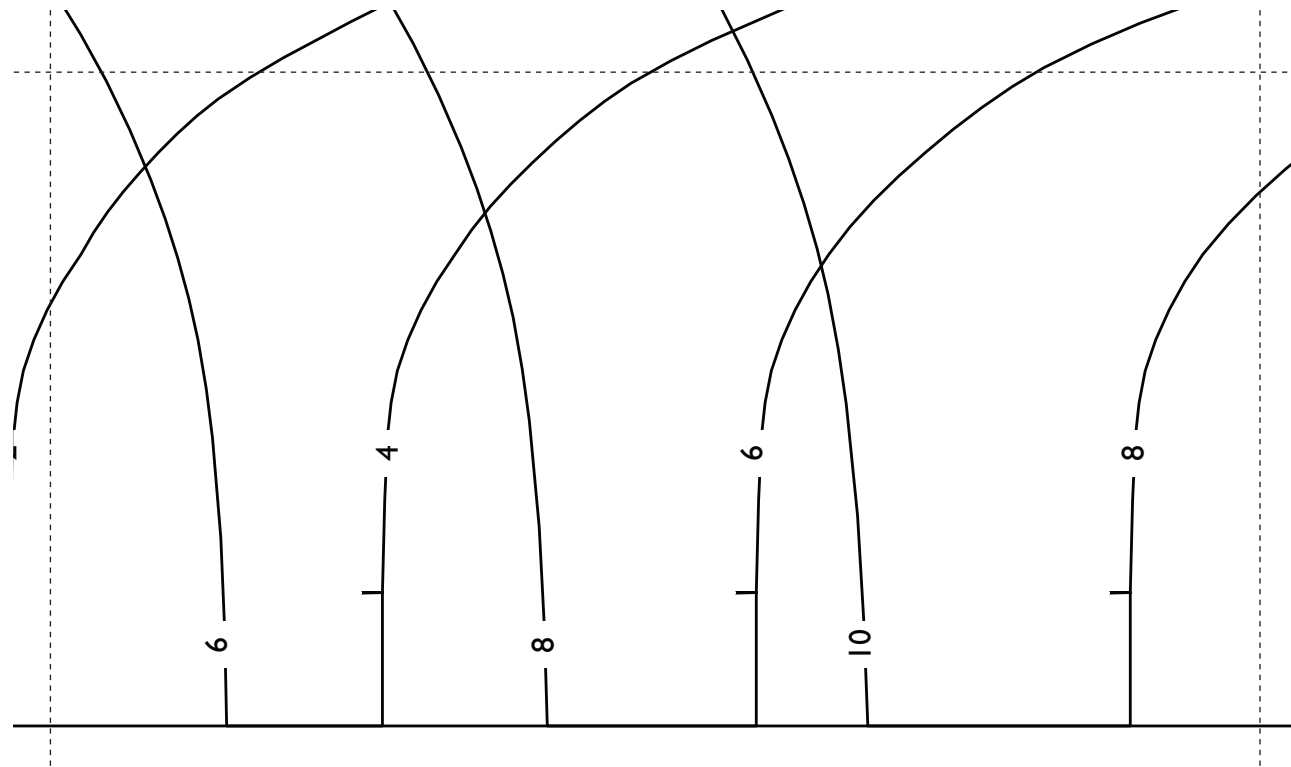
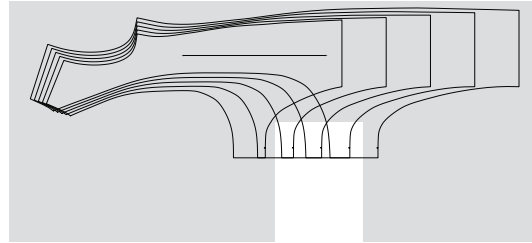

# Onesie Version B

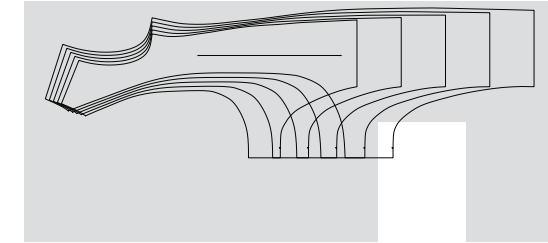

FRONT  
Enlarge by 141% on a  
photocopier and join  
along dotted lines.

Cut 1 Pair

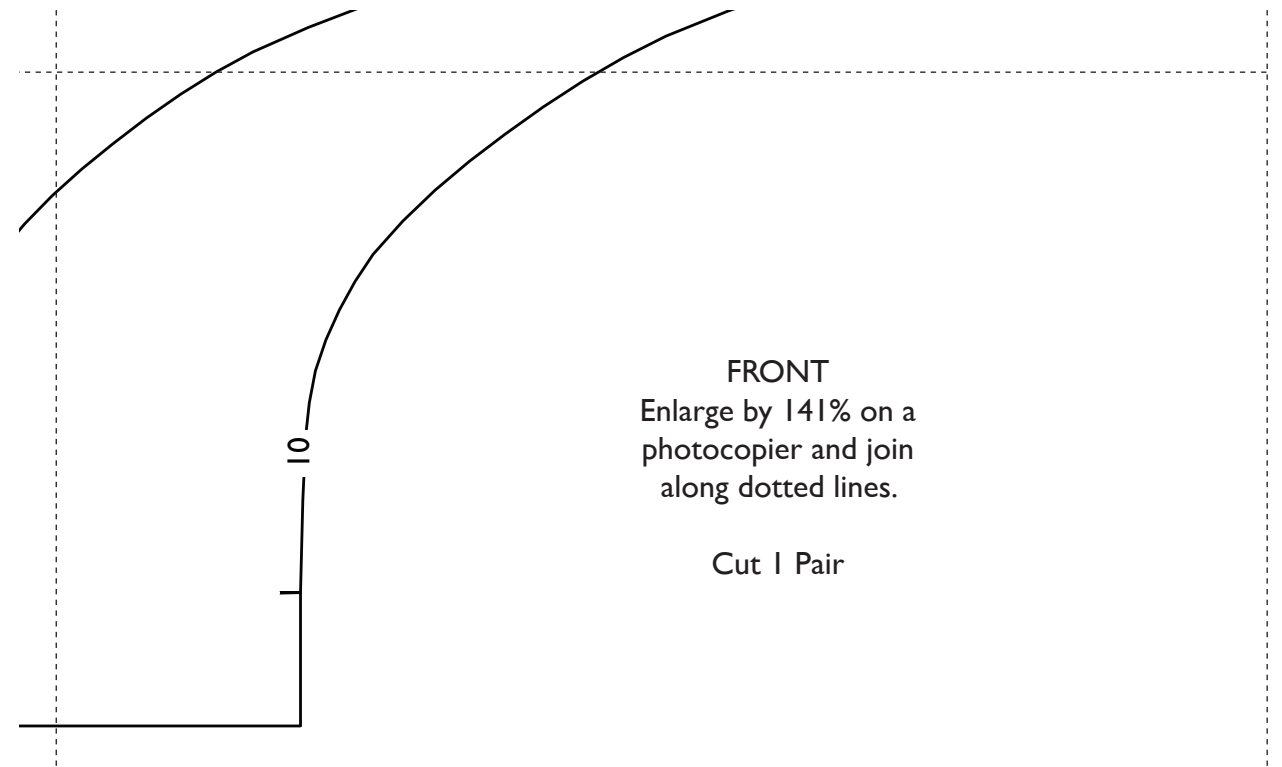

# Cat

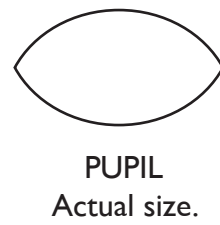
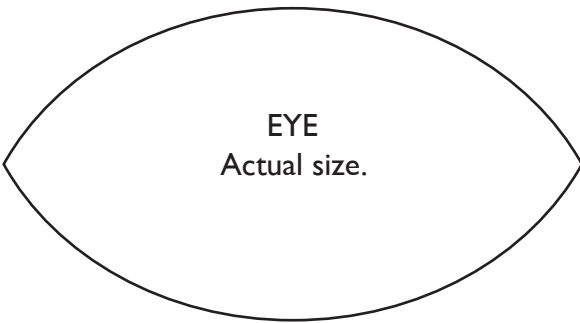
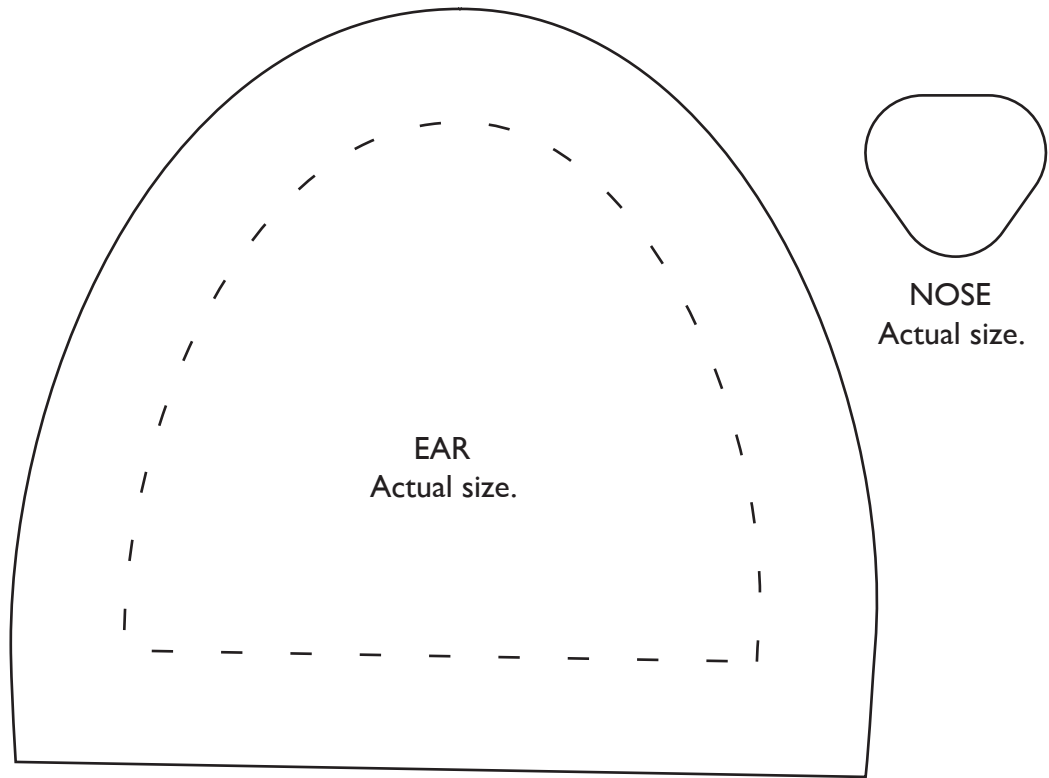

# Tiger

